



COLLIN COUNTY

**Public Works Weston Barn Metal Roof
Replacement**

IFB 2016-322

**J. D. Griffin, CPPB
Jack Hatchell Administration Building
2300 Bloomdale Road, Ste. 3160
McKinney, TX 75071**

**(P) 972-548-4116 (F) 972-548-4694
jgriffin@collincountytx.gov**

Collin County exclusively uses IonWave Technologies, Inc. ([Collin County eBid](#)) for the notification and dissemination of all solicitations. The receipt of solicitations through any other means may result in your receipt of incomplete specifications and/or addendums which could ultimately render your bid/proposal non-compliant. Collin County accepts no responsibility for the receipt and/or notification of solicitations through any other means.

LEGAL NOTICE

By order of the Commissioners' Court of Collin County, Texas, sealed bids will be received by the Purchasing Agent, 2300 Bloomdale, Suite 3160, McKinney, TX 75071, until **2:00 P.M., Thursday, October 6, 2016**, for Invitation For Bid **Public Works Weston Barn Metal Roof Replacement (IFB No. 2016-322)**. A **Pre-Bid Site-Walk** will be held **Tuesday, September 27, 2016 at 2:00 p.m.** at Collin County Public Works Weston Barn, 3821 W. FM 455, Anna, TX 75409. Bidders shall use lump sum pricing. Contractor must furnish a performance and payment bond within ten (10) consecutive calendar days following award of contract. Funds for payment have been provided through the Collin County budget approved by the Commissioner's Court for this fiscal year only. Bidders may obtain detailed specifications and other documents at Office of the Purchasing Agent: Collin County Administration Building, 2300 Bloomdale, Suite 3160, McKinney, TX 75071, 972-548-4165, or by going to: <https://collincountytx.ionwave.net>. Sealed bids will be opened on **Thursday, October 6, 2016 at 2:00 P.M.** by the Purchasing Agent, 2300 Bloomdale, Suite 3160, McKinney, TX 75071. The Commissioners' Court reserves the right to reject any and all bids.

.....

ATTENTION: CLASSIFIEDS
BILL TO: ACCOUNT NO 06100315-000
COMMISSIONER'S COURT

NOTICE TO PUBLISHERS: Please publish in your issue on **Thursday, September 15, 2016** and **Thursday, September 22, 2016**. A copy of this notice and the publisher's affidavit must accompany the invoice when presented for payment.

NEWSPAPER: Plano Star Courier
DATE: September 13, 2016
FAX: 972-529-1684

Collin County, Texas

Bid Information

Bid Owner JD Griffin, CPPB Buyer II
Email jgriffin@co.collin.tx.us
Phone (972) 548-4116
Fax (972) 548-4694

Bid Number 2016-322
Title Public Works Weston Barn Metal
Roof Replacement

Bid Type IFB
Issue Date 09/13/2016
Close Date 10/6/2016 02:00:00 PM (CT)

Contact Information

Address 2300 Bloomdale Rd.
Ste. 3160
McKinney, TX 75071

Contact JD Griffin, CPPB Buyer II
Department Purchasing
Building Admin. Building
Floor/Room Ste.3160
Telephone (972) 548-4116
Fax (972) 548-4694
Email jgriffin@co.collin.tx.us

Ship to Information

Address 3821 W. FM 455
Anna, TX 75409

Contact
Department
Building Public Works Weston Barn
Floor/Room
Telephone
Fax
Email

Supplier Information

Company Name _____
Contact Name _____
Address _____

Telephone _____
Fax _____
Email _____

Supplier Notes

The undersigned hereby certifies the foregoing bid submitted by the company listed below hereinafter called "bidder" is the duly authorized agent of said company and the person signing said bid has been duly authorized to execute same. Bidder affirms that they are duly authorized to execute this contract; this company; corporation, firm, partnership or individual has not prepared this bid in collusion with any other bidder or other person or persons engaged in the same line of business; and that the contents of this bid as to prices, terms and conditions of said bid have not been communicated by the undersigned nor by any employee or agent to any other person engaged in this type of business prior to the official opening of this bid.

Signature _____

Date ____ / ____ / ____

Bid Notes

Please log in to view bid documents.

Bid Activities

Date	Name	Description
9/27/2016 02:00:00 PM (CT)	Pre-bid Site Walk (Non Mandatory)	A pre-bid site walk will be held on September 27, 2016 at 2:00 PM. The location of the pre-bid site walk will be at the Collin County Public Works Weston Barn, 3821 W. FM 455, Anna, TX 75409 (refer to Attachment A for location). It is the bidder's responsibility to review the site and documents to gain a full understanding of the requirements of the project.
9/30/2016 05:00:00 PM (CT)	Question Deadline	Deadline to submit questions is 5:00 p.m., September 30, 2016. Please email questions to J. D. Griffin at jgriffin@co.collin.tx.us
9/30/2016 05:00:00 PM (CT)	Intent to Bid	Do you intend to submit a bid?

Bid Messages

Bid Attachments

The following attachments are associated with this opportunity and will need to be retrieved separately

Line	Filename	Description
Header	LEGAL NOTICE-2016-322.doc	Legal Notice
Header	General Instructions_Bid.docx	General Instructions_Bid
Header	Terms of Contract_Bid.docx	Terms of Contract - Bid
Header	3.0 Insurance_Requirements.doc	3.0 Insurance Requirements
Header	4.0 Special Conditions and Specifications.doc	4.0 Special Conditions and Specifications
Header	Attachment A.pdf	Attachment A-Pre Bid Location
Header	Attachment B.pdf	Attachment B-Roof Panel Specifications
Header	Attachment C.pdf	Attachment C-Trim Specifications
Header	Attachment D.pdf	Attachment D-Fastener Specifications
Header	Attachment E.pdf	Attachment E-Snow Guard Specifications
Header	Attachment F.pdf	Attachment F-Existing Building Pictures
Header	Attachment G.docx	Attachment G-Prevailing Wage Rates
Header	Construction Contract.docx	Construction Contract
Header	Payment Bond.pdf	Payment Bond
Header	Performance Bond.pdf	Performance Bond
Header	HB23 CIQ.docx	Information Regarding Conflict of Interest Questionnaire
Header	CIQ_113015.pdf	Conflict of Interest Questionnaire
Header	W9_2014.pdf	W-9

Bid Attributes

Please review the following and respond where necessary

#	Name	Note	Response
1	Calendar Days Bid	Please state the consecutive calendar days bid.	_____ (Required)
2	Exceptions	Do you take exceptions to the specifications. If so, by separate attachment, please state your exceptions. Valid Responses: [Please Select], Yes, No	_____ (Required)
3	Insurance	I understand that the insurance requirements of this solicitation are required and a certificate of insurance shall be submitted to the Purchasing department if I am awarded all or a portion of the resulting contract. Please initial.	_____ (Required)

- 4 Subcontractors State the business name of all subcontractors and the type of work they will be performing under this contract. _____ (Required)
- If you are fully qualified to self-perform the entire contract, please respond with "Not Applicable-Self Perform".
- 5 Reference No. 1 List a company or governmental agency where these same/like products /services, as stated herein, have been provided. _____ (Required)
- Include the following: Company/Entity, Contact, Address, City/State/Zip, Phone, and E-Mail.
- 6 Reference No. 2 List a company or governmental agency where these same/like products /services, as stated herein, have been provided. _____ (Required)
- Include the following: Company/Entity, Contact, Address, City/State/Zip, Phone, and E-Mail.
- 7 Reference No. 3 List a company or governmental agency where these same/like products /services, as stated herein, have been provided. _____ (Required)
- Include the following: Company/Entity, Contact, Address, City/State/Zip, Phone, and E-Mail.
- 8 Preferential Treatment The County of Collin, as a governmental agency of the State of Texas, may not award a contract to a nonresident bidder unless the nonresident's bid is lower than the lowest bid submitted by a responsible Texas resident bidder by the same amount that a Texas resident bidder would be required to underbid a nonresident bidder to obtain a comparable contract in the state in which the nonresident's principal place of business is located (Government Code, Title 10, V.T.C.A., Chapter 2252, Subchapter A). _____ (Required)
1. Is your principal place of business in the State of Texas?
2. If your principal place of business is not in Texas, in which State is your principal place of business?
3. If your principal place of business is not in Texas, does your state favor resident bidders (bidders in your state) by some dollar increment or percentage?
4. If your state favors resident bidders, state by what dollar amount or percentage.
- 9 Debarment Certification I certify that neither my company nor an owner or principal of my company has been debarred, suspended or otherwise made ineligible for participation in Federal Assistance programs under Executive Order 12549, "Debarment and Suspension," as described in the Federal Register and Rules and Regulations. _____ (Required)
- Please initial.

- 10 Immigration and Reform Act _____ (Required)
- I declare and affirm that my company is in compliance with the Immigration and Reform Act of 1986 and all employees are legally eligible to work in the United States of America.
- I further understand and acknowledge that any non-compliance with the Immigration and Reform Act of 1986 at any time during the term of this contract will render the contract voidable by Collin County.
- Please initial.
- 11 Disclosure of Certain Relationships _____ (Required)
- Chapter 176 of the Texas Local Government Code requires that any vendor considering doing business with a local government entity disclose the vendor's affiliation or business relationship that might cause a conflict of interest with a local government entity. Subchapter 6 of the code requires a vendor to file a conflict of interest questionnaire (CIQ) if a conflict exists. By law this questionnaire must be filed with the records administrator of Collin County no later than the 7th business day after the date the vendor becomes aware of an event that requires the statement to be filed. A vendor commits an offense if the vendor knowingly violates the code. An offense under this section is a misdemeanor.
- By submitting a response to this request, the vendor represents that it is in compliance with the requirements of Chapter 176 of the Texas Local Government Code.
- Please send completed forms to the Collin County County Clerk's Office located at 2300 Bloomdale Rd., Suite 2104, McKinney, TX 75071.
- Please initial.
- 12 Disclosure of Interested Parties _____ (Required)
- Section 2252.908 of the Texas Government Code requires a business entity entering into certain contracts with a governmental entity to file with the governmental entity a disclosure of interested parties at the time the business entity submits the signed contract to the governmental entity. Section 2252.908 requires the disclosure form (Form 1295) to be signed by the authorized agent of the contracting business entity, acknowledging that the disclosure is made under oath and under penalty of perjury. Section 2252.908 applies only to a contract that requires an action or vote by the governing body of the governmental entity before the contract may be signed or has a value of at least \$1 million. Section 2252.908 provides definitions of certain terms occurring in the section.
- Section 2252.908 applies only to a contract entered into on or after January 1, 2016.
- Please initial.
- 13 Notification Survey _____ (Required)
- In order to better serve our offerors, the Collin County Purchasing Department is conducting the following survey. We appreciate your time and effort expended to submit your bid. Should you have any questions or require more information please call (972) 548-4165.
- How did you receive notice of this request?
Valid Responses: [Please Select], Plano Star Courier, Plano Room, Collin County eBid Notification, Collin County Website, Other

Bidder, declares that the only person or parties interested in this bid are those principals named herein, that his/her bid is made without collusion with any other person, firm or corporation, that he/she has carefully examined the Contract Documents including the Advertisement for Bids, Instruction to Bidders, Construction Agreement, Specifications and the Drawings, therein referred to and has carefully examined the locations, conditions and classes of materials for the proposed work, and agrees that he/she will provide all the necessary labor, machinery, tools, equipment, apparatus and other items incidental to construction and will do all the work and furnish all the materials called for in the Contract Documents in the manner prescribed therein. _____ (Required)

Bidder hereby declares that he/she has visited the site of the Work and has carefully examined the Contract Documents pertaining to the Work covered by the above Bid, and he/she further agrees to commence work within ten (10) consecutive calendar days after date of written Notice to Proceed and to substantially complete the work on which he/she has bid within the number of days specified subject to such extensions of time allowed by Specifications.

Bidder certifies that the bid prices contained in this bid have been carefully checked and are submitted as correct and final. The prices have been shown in words and figures for each item listed in this bid and it is understood that in the event of a discrepancy, the words shall govern.

Please initial.

Line Items

#	Qty	UOM	Description	Response
1	1	lump sum	Bid Grand Total	\$ _____ (Required) Price

Supplier Notes: _____

Item Attributes: Please review the following and respond where necessary

#	Name	Note	Response
1	Bid Grand Total- Written in Words	The contract award will be based on the total bid price.	_____ (Required)
2	Total Material Cost Incorporated in Project- Written in Words		_____ (Required)
3	Total Labor Cost Incorporated in Project- Written in Words		_____ (Required)

1.0 GENERAL INSTRUCTIONS

1.0.1 Definitions

1.0.1.1 Bidder: refers to submitter.

1.0.1.2 Vendor/Contractor/Provider: refers to a Successful Bidder/Contractor/Service Provider.

1.0.1.3 Submittal: refers to those documents required to be submitted to Collin County, by a Bidder.

1.0.1.4 IFB: refers to Invitation For Bid.

1.1 If Bidder does not wish to submit an offer at this time, please submit a No Bid.

1.2 Awards shall be made not more than ninety (90) days after the time set for opening of submittals.

1.3 Collin County is always conscious and extremely appreciative of your time and effort in preparing your submittal.

1.4 Collin County exclusively uses ionWave Technologies, Inc. (Collin County eBid) for the notification and dissemination of all solicitations. The receipt of solicitations through any other company may result in your receipt of incomplete specifications and/or addendums which could ultimately render your bid non-compliant. Collin County accepts no responsibility for the receipt and/or notification of solicitations through any other company.

1.5 A bid may not be withdrawn or canceled by the bidder prior to the ninety-first (91st) day following public opening of submittals and only prior to award.

1.6 It is understood that Collin County, Texas reserves the right to accept or reject any and/or all Bids for any or all products and/or services covered in an Invitation For Bid (IFB), and to waive informalities or defects in submittals or to accept such submittals as it shall deem to be in the best interest of Collin County.

1.7 All IFB's submitted in hard copy paper form shall be submitted in a sealed envelope, plainly marked on the outside with the IFB number and name. A hard copy paper form submittal shall be manually signed in ink by a person having the authority to bind the firm in a contract. Submittals shall be mailed or hand delivered to the Collin County Purchasing Department.

1.8 No oral, telegraphic or telephonic submittals will be accepted. IFB's may be submitted in electronic format via Collin County eBid.

1.9 All Invitation For Bids (IFB) submitted electronically via Collin County eBid shall remain locked until official date and time of opening as stated in the Special Terms and Conditions of the IFB.

1.10 Time/date stamp clock in Collin County Purchasing Department shall be the official time of receipt for all Invitation for Bids (IFB) submitted in hard copy paper form. IFB's received in the Collin County Purchasing Department after submission deadline shall be considered void and unacceptable. Absolutely no late submittals will be considered. Collin County accepts no responsibility for technical difficulties related to electronic submittals.

1.11 For hard copy paper form submittals, any alterations made prior to opening date and time must be initialed by the signer of the IFB guaranteeing authenticity. Submittals cannot be altered or amended after submission deadline.

1.12 Collin County is by statute exempt from the State Sales Tax and Federal Excise Tax; therefore, the prices submitted shall not include taxes.

1.13 Any interpretations, corrections and/or changes to an Invitation For Bid, and related Specifications or extensions to the opening/receipt date will be made by addenda to the respective document by the Collin County Purchasing Department. Questions and/or clarification requests must be submitted no later than seven (7) days prior to the opening/receipt date. Those received at a later date may not be addressed prior to the public opening. Sole authority to authorize addenda shall be vested in Collin County Purchasing Agent as entrusted by the Collin County Commissioners' Court. Addenda may be transmitted electronically via Collin County eBid.

1.13.1 Addenda will be transmitted to all that are known to have received a copy of the IFB/RFQ/RFP/RFI/CSP and related Specifications. However, it shall be the sole responsibility of the Bidder/Quoter/Offeror to verify issuance/non-issuance of addenda and to check all avenues of document availability (i.e. **Collin County eBid** <https://collincountvtx.ionwave.net/>, telephoning Purchasing Department directly, etc.) prior to opening/receipt date and time to insure Bidder/Quoter/Offeror's receipt of any addenda issued. Bidder/Quoter/Offeror shall acknowledge receipt of all addenda.

1.14 All materials and services shall be subject to Collin County approval.

1.15 Collin County reserves the right to make award in whole or in part as it deems to be in the best interest of the County.

1.16 Any reference to model/make and/or manufacturer used in specifications is for descriptive purposes only. Products/materials of like quality will be considered.

1.17 Bidders taking exception to the specifications shall do so at their own risk. By offering substitutions, Bidder shall state these exceptions in the section provided in the IFB or by attachment. Exception/substitution, if accepted, must meet or exceed specifications stated therein. Collin County reserves the right to accept or reject any and/or all of the exception(s)/substitution(s) deemed to be in the best interest of the County.

1.19 Minimum Standards for Responsible Prospective Bidders: A prospective Bidder must meet the following minimum requirements:

1.19.1 have adequate financial resources, or the ability to obtain such resources as required;

1.19.2 be able to comply with the required or proposed delivery/completion schedule;

1.19.3 have a satisfactory record of performance;

1.19.4 have a satisfactory record of integrity and ethics;

1.19.5 be otherwise qualified and eligible to receive an award.

Collin County may request documentation and other information sufficient to determine Bidder's ability to meet these minimum standards listed above.

1.20 Vendor shall bear any/all costs associated with it's preparation of an IFB.

1.21 Public Information Act: Collin County is governed by the Texas Public Information Act, Chapter 552 of the Texas Government Code. All information submitted by prospective bidders during the bidding process is subject to release under the Act.

1.22 The Bidder shall comply with Commissioners' Court Order No. 2004-167-03-11, County Logo Policy.

1.23 Interlocal Agreement: Successful bidder agrees to extend prices and terms to all entities that has entered into or will enter into joint purchasing interlocal cooperation agreements with Collin County.

1.24 Bid Openings: All bids submitted will be read at the county's regularly scheduled bid opening for the designated project. However, the reading of a bid at bid opening should be not construed as a comment on the responsiveness of such bid or as any indication that the county accepts such bid as responsive.

The county will make a determination as to the responsiveness of bids submitted based upon compliance with all applicable laws, Collin County Purchasing Guidelines, and project documents, including but not limited to the project specifications and contract documents. The county will notify the successful bidder upon award of the contract and, according to state law; all bids received will be available for inspection at that time.

2.0 TERMS OF CONTRACT

2.1 A bid, when properly accepted by Collin County, shall constitute a contract equally binding between the Vendor/Contractor/Provider and Collin County. No different or additional terms will become part of this contract with the exception of a Change Order.

2.2 No oral statement of any person shall modify or otherwise change, or affect the terms, conditions or specifications stated in the resulting contract. All Amendments and/or Change Orders to the contract will be made in writing by Collin County Purchasing Agent.

2.3 No public official shall have interest in the contract, in accordance with Vernon's Texas Codes Annotated, Local Government Code Title 5, Subtitle C, Chapter 171.

2.4 The Vendor/Contractor/Provider shall comply with Commissioners' Court Order No. 96-680-10-28, Establishment of Guidelines & Restrictions Regarding the Acceptance of Gifts by County Officials & County Employees.

2.5 Design, strength, quality of materials and workmanship must conform to the highest standards of manufacturing and engineering practice.

2.6 Bids must comply with all federal, state, county and local laws concerning the type(s) of product(s)/service(s)/equipment/project(s) contracted for, and the fulfillment of all ADA (Americans with Disabilities Act) requirements.

2.7 All products must be new and unused, unless otherwise specified, in first-class condition and of current manufacture. Obsolete products, including products or any parts not compatible with existing hardware/software configurations will not be accepted.

2.8 Vendor/Contractor/Provider shall provide any and all notices as may be required under the Drug-Free Work Place Act of 1988, 28 CFR Part 67, Subpart F, to its employees and all sub-contractors to insure that Collin County maintains a drug-free work place.

2.9 Vendor/Contractor/Provider shall defend, indemnify and save harmless Collin County and all its officers, agents and employees and all entities, their officers, agents and employees who are participating in this contract from all suits, claims, actions, damages (including personal injury and or property damages), or demands of any character, name and description, (including attorneys' fees, expenses and other defense costs of any nature) brought for or on account of any injuries or damages received or sustained by any person, persons, or property on account of Vendor/Contractor/Provider's breach of the contract arising from an award, and/or any negligent act, error, omission or fault of the Vendor/Contractor/Provider, or of any agent, employee, subcontractor or supplier of Vendor/Contractor/Provider in the execution of, or performance under, any contract which may result from an award. Vendor/Contractor/Provider shall pay in full any judgment with costs, including attorneys' fees and expenses which are rendered against Collin County and/or participating entities arising out of such breach, act, error, omission and/or fault.

2.10 Expenses for Enforcement. In the event either Party hereto is required to employ an attorney to enforce the provisions of this Agreement or is required to commence legal proceedings to enforce the provisions hereof, the prevailing Party shall be entitled to recover from the other, reasonable attorney's fees and court costs incurred in connection with such enforcement, including collection.

2.11 If a contract, resulting from a Collin County IFB is for the execution of a public work, the following shall apply:

2.11.1 In accordance with V.T.C.A. 2253.021, a governmental agency that makes a public work contract with a prime contractor shall require the contractor, before beginning work, to execute to the governmental entity a Payment Bond if the contract is in excess of \$25,000.00. Such bond shall

be in the amount of the contract payable to the governmental entity and must be executed by a corporate surety in accordance with Section 1, Chapter 87, Acts of the 56th Legislature, Regular Session, 1959 (Article 7.19-1 Vernon's Texas Insurance Code).

2.11.2 In accordance with V.T.C.A. 2253.021, a governmental agency that makes a public work contract with a prime contractor shall require the contractor, before beginning work, to execute to the governmental entity a Performance Bond if the contract is in excess of \$100,000.00. Such bond shall be in the amount of the contract payable to the governmental entity and must be executed by a corporate surety in accordance with Section 1, Chapter 87, Acts of the 56th Legislature, Regular Session, 1959 (Article 7.19-1 Vernon's Texas Insurance Code).

2.12 Purchase Order(s) shall be generated by Collin County to the vendor. Collin County will not be responsible for any orders placed/delivered without a valid purchase order number.

2.13 The contract shall remain in effect until any of the following occurs: delivery of product(s) and/or completion and acceptance by Collin County of product(s) and/or service(s), contract expires or is terminated by either party with thirty (30) days written notice prior to cancellation and notice must state therein the reasons for such cancellation. Collin County reserves the right to terminate the contract immediately in the event the Vendor/Contractor/Provider fails to meet delivery or completion schedules, or otherwise perform in accordance with the specifications. Breach of contract or default authorizes the County to purchase elsewhere and charge the full increase in cost and handling to the defaulting Vendor/Contractor/Provider.

2.14 Collin County Purchasing Department shall serve as Contract Administrator or shall supervise agents designated by Collin County.

2.15 All delivery and freight charges (FOB Inside delivery at Collin County designated locations) are to be included as part of the bid price. All components required to render the item complete, installed and operational shall be included in the total bid price. Collin County will pay no additional freight/delivery/installation/setup fees.

2.16 Vendor/Contractor/Provider shall notify the Purchasing Department immediately if delivery/completion schedule cannot be met. If delay is foreseen, the Vendor/Contractor/Provider shall give written notice to the Purchasing Agent. The County has the right to extend delivery/completion time if reason appears valid.

2.17 The title and risk of loss of the product(s) shall not pass to Collin County until Collin County actually receives and takes possession of the product(s) at the point or points of delivery. Collin County shall generate a purchase order(s) to the Vendor/Contractor/Provider and the purchase order number must appear on all itemized invoices.

2.18 Invoices shall be mailed directly to the Collin County Auditor's Office, 2300 Bloomdale Road, Suite 3100, McKinney, Texas 75071. All invoices shall show:

2.18.1 Collin County Purchase Order Number;

2.18.2 Vendor's/Contractor's/Provider's Name, Address and Tax Identification Number;

2.18.3 Detailed breakdown of all charges for the product(s) and/or service(s) including applicable time frames.

2.19 Payment will be made in accordance with V.T.C.A., Government Code, Title 10, Subtitle F, Chapter 2251.

2.20 All warranties shall be stated as required in the Uniform Commercial Code.

2.21 The Vendor/Contractor/Provider and Collin County agree that both parties have all rights, duties, and remedies available as stated in the Uniform Commercial Code.

- 2.22 The Vendor/Contractor/Provider agree to protect Collin County from any claims involving infringements of patents and/or copyrights.
- 2.23 The contract will be governed by the laws of the State of Texas. Should any portion of the contract be in conflict with the laws of the State of Texas, the State laws shall invalidate only that portion. The remaining portion of the contract shall remain in effect. The contract is performable in Collin County, Texas.
- 2.24 The Vendor/Contractor/Provider shall not sell, assign, transfer or convey the contract, in whole or in part, without the prior written approval from Collin County.
- 2.25 The apparent silence of any part of the specification as to any detail or to the apparent omission from it of a detailed description concerning any point, shall be regarded as meaning that only the best commercial practices are to prevail. All interpretations of the specification shall be made on the basis of this statement.
- 2.26 Vendor/Contractor/Provider shall not fraudulently advertise, publish or otherwise make reference to the existence of a contract between Collin County and Vendor/Contractor/Provider for purposes of solicitation. As exception, Vendor/Contractor/Provider may refer to Collin County as an evaluating reference for purposes of establishing a contract with other entities.
- 2.27 The Vendor/Contractor/Provider understands, acknowledges and agrees that if the Vendor/Contractor/Provider subcontracts with a third party for services and/or material, the primary Vendor/Contractor/Provider (awardee) accepts responsibility for full and prompt payment to the third party. Any dispute between the primary Vendor/Contractor/Provider and the third party, including any payment dispute, will be promptly remedied by the primary vendor. Failure to promptly render a remedy or to make prompt payment to the third party (subcontractor) may result in the withholding of funds from the primary Vendor/Contractor/Provider by Collin County for any payments owed to the third party.
- 2.28 Vendor/Contractor/Provider shall provide Collin County with diagnostic access tools at no additional cost to Collin County, for all Electrical and Mechanical systems, components, etc., procured through this contract.
- 2.29 Criminal History Background Check: If required, ALL individuals may be subject to a criminal history background check performed by the Collin County Homeland Security prior to access being granted to Collin County. Upon request, Vendor/Contractor/Provider shall provide list of individuals to Collin County Purchasing Department within five (5) working days.
- 2.30 Non-Disclosure Agreement: Where applicable, vendor shall be required to sign a non-disclosure agreement acknowledging that all information to be furnished is in all respects confidential in nature, other than information which is in the public domain through other means and that any disclosure or use of same by vendor, except as provided in the contract/agreement, may cause serious harm or damage to Collin County. Therefore, Vendor agrees that Vendor will not use the information furnished for any purpose other than that stated in contract/agreement, and agrees that Vendor will not either directly or indirectly by agent, employee, or representative disclose this information, either in whole or in part, to any third party, except on a need to know basis for the purpose of evaluating any possible transaction. This agreement shall be binding upon Collin County and Vendor, and upon the directors, officers, employees and agents of each.
- 2.31 Vendors/Contractors/Providers must be in compliance with the Immigration and Reform Act of 1986 and all employees specific to this solicitation must be legally eligible to work in the United States of America.
- 2.32 Certification of Eligibility: This provision applies if the anticipated Contract exceeds \$100,000.00 and as it relates to the expenditure of federal grant funds. By submitting a bid or proposal in response to this solicitation, the Bidder certifies that at the time of submission, he/she is not on the Federal Government's list of suspended, ineligible, or debarred contractors. In the event of placement on the list between the time of bid/proposal submission and time of award, the Bidder will notify the Collin County Purchasing Agent. Failure to do so may result in terminating this contract for default.

2.33 Notice to Vendors/Contractors/Providers delivering goods or performing services within the Collin County Detention Facility: The Collin County Detention Facility houses persons who have been charged with and/or convicted of serious criminal offenses. When entering the Detention Facility, you could: (1) hear obscene or graphic language; (2) view partially clothed male inmates; (3) be subjected to verbal abuse or taunting; (4) risk physical altercations or physical contact, which could be minimal or possibly serious; (5) be exposed to communicable or infectious diseases; (6) be temporarily detained or prevented from immediately leaving the Detention Facility in the case of an emergency or “lockdown”; and (7) subjected to a search of your person or property. While the Collin County Sheriff’s Office takes every reasonable precaution to protect the safety of visitors to the Detention Facility, because of the inherently dangerous nature of a Detention Facility and the type of the persons incarcerated therein, please be advised of the possibility of such situations exist and you should carefully consider such risks when entering the Detention Facility. By entering the Collin County Detention Facility, you acknowledge that you are aware of such potential risks and willingly and knowingly choose to enter the Collin County Detention Facility.

2.34 Delays and Extensions of Time when applicable:

2.34.1 If the Vendor/Contractor/Provider is delayed at any time in the commence or progress of the Work by an act or neglect of the Owner or Architect/Engineer, or of an employee of either, or of a separate contractor employed by the Owner, or by changes ordered in the Work, or by labor disputes, fire, unusual delay in deliveries, unavoidable casualties or other causes beyond the Vendor/Contractor/Provider's control, or by delay authorized by the Owner pending mediation and arbitration, or by other causes which the Owner or Architect/Engineer determines may justify delay, then the Contract Time shall be extended by Change Order for such reasonable time as the Owner/Architect may determine.

2.34.2 If adverse weather conditions are the basis for a Claim for additional time, such Claim shall be documented by data substantiating that weather conditions were abnormal for the period of time and could not have been reasonably anticipated, and that the weather conditions had an adverse effect on the scheduled construction.

2.35 Disclosure of Certain Relationships: Chapter 176 of the Texas Local Government Code requires that any vendor considering doing business with a local government entity disclose the vendor’s affiliation or business relationship that might cause a conflict of interest with a local government entity. Subchapter 6 of the code requires a vendor to file a conflict of interest questionnaire (CIQ) if a conflict exists. By law this questionnaire must be filed with the records administrator of Collin County no later than the 7th business day after the date the vendor becomes aware of an event that requires the statement to be filed. A vendor commits an offense if the vendor knowingly violates the code. An offense under this section is a misdemeanor. By submitting a response to this request, the vendor represents that it is in compliance with the requirements of Chapter 176 of the Texas Local Government Code. Please send completed forms to the Collin County County Clerk’s Office located at 2300 Bloomdale Rd., Suite 2104, McKinney, TX 75071.

2.36 Disclosure of Interested Parties: Section 2252.908 of the Texas Government Code requires a business entity entering into certain contracts with a governmental entity to file with the governmental entity a disclosure of interested parties at the time the business entity submits the signed contract to the governmental entity. Section 2252.908 requires the disclosure form (Form 1295) to be signed by the authorized agent of the contracting business entity, acknowledging that the disclosure is made under oath and under penalty of perjury. Section 2252.908 applies only to a contract that requires an action or vote by the governing body of the governmental entity before the contract may be signed or has a value of at least \$1 million. Section 2252.908 provides definitions of certain terms occurring in the section. Section 2252.908 applies only to a contract entered into on or after January 1, 2016.

NOTE: All other terms and conditions (i.e. Insurance Requirements, Bond Requirements, etc.) shall be stated in the individual IFB Solicitation documents as Special Terms, Conditions and Specifications.

3.0 INSURANCE REQUIREMENTS

3.1 Before commencing work, the vendor shall be required, at its own expense, to furnish the Collin County Purchasing Agent with certified copies of all insurance certificate(s) indicating the coverage to remain in force throughout the term of this contract.

3.1.1 **Commercial General Liability** insurance including but not limited to the coverage indicated below. Coverage shall not exclude or limit Products/Completed Operations, Contractual Liability, or Cross Liability.

- Each Occurrence: \$1,000,000
- Personal & Adv Injury: \$1,000,000
- Products/Completed Operation: \$2,000,000
- General Aggregate: \$2,000,000

3.1.2 **Workers Compensation** insurance as required by the laws of Texas, and Employers' Liability.

Employers' Liability

- Liability, Each Accident: \$500,000
- Disease-Each Employee: \$500,000
- Disease – Policy Limit: \$500,000

3.1.3 **Commercial Automobile Liability** insurance including owned, non-owned, and hired vehicles used in connection with the contract.

- Combined Single Limit – Each Accident: \$1,000,000

3.1.4 **Umbrella/Excess Liability** insurance.

- Each Occurrence/Aggregate: \$1,000,000

3.2 With reference to the foregoing insurance requirement, the vendor shall endorse applicable insurance policies as follows:

3.2.1 A waiver of subrogation in favor of Collin County, its officials, employees, volunteers and officers shall be provided for General Liability, Commercial Automobile Liability and Workers' Compensation.

3.2.2 The vendor's insurance coverage shall name Collin County as additional insured under the General Liability policy.

3.2.3 All insurance policies shall be endorsed to require the insurer to immediately notify Collin County of any decrease in the insurance coverage limits.

3.2.4 All insurance policies shall be endorsed to the effect that Collin County will receive at least thirty (30) days notice prior to cancellation, non-renewal or termination of the policy.

3.2.5 All copies of Certificates of Insurance shall reference the project/contract number.

3.3 All insurance shall be purchased from an insurance company that meets the following requirements:

3.3.1 A financial rating of A+VII or better as assigned by the BEST Rating Company or equivalent.

3.4 Certificates of Insurance shall be prepared and executed by the insurance company or its authorized agent, and shall contain provisions representing and warranting the following:

3.4.1 Sets forth all endorsements and insurance coverages according to requirements and instructions contained herein.

3.4.2 Sets forth the notice of cancellation or termination to Collin County.

4.0 SPECIAL CONDITIONS AND SPECIFICATIONS

4.1 Authorization: By order of the Commissioners' Court of Collin County, Texas sealed bids will be received for Public Works Weston Barn Metal Roof Replacement.

4.2 Purpose: The intended use/purpose for this Invitation for Bid is to describe Public Works Weston Barn Roof Replacement. This project requires removal of the existing metal roof and installation of new metal roof panels and trim. The project will be awarded to the contractor providing the lowest and best bid meeting specifications.

4.3 Pre-Bid Site Walk (Non-mandatory): A pre-bid site walk will be held on September 27, 2016 at 2:00 PM. The location of the pre-bid site walk will be at the Collin County Public Works Weston Barn, 3821 W. FM 455, Anna, TX 75409 (refer to Attachment A for location). It is the bidder's responsibility to review the site and documents to gain a full understanding of the requirements of the project.

4.4 Funding: Funds for payment have been provided through the Collin County budget approved by the Commissioners' Court for this fiscal year only. State of Texas statutes prohibit the County from any obligation of public funds beyond the fiscal year for which a budget has been approved. Therefore, anticipated orders or other obligations that may arise past the end of the current Collin County fiscal year shall be subject to budget approval.

4.5 Delivery Time: Vendor shall state the number of calendar days to complete services at the County's designated location after receipt of purchase order in the space provided on Attribute 1.

4.6 Fabrication/Delivery/Setup/Installation Location: Location for delivery and installation is Collin County Public Works Weston Barn, 3821 W. FM 455, Anna, TX 75409.

4.7 Freight/Delivery Charges: Shall be included in the bid price. No additional fees for delivery/freight/fuel surcharge or other fees shall be invoiced or paid by Collin County.

4.8 Testing: Testing may be performed at the request of Collin County, by an agent so designated by the County, without expense to Collin County.

4.9 Samples/Demos: When requested, samples/demos shall be furnished to the County at no expense.

4.10 Approximate Expenditure: The approximate expenditure by Collin County for this project is \$12,500. Approximate expenditure does not constitute an order, but only implies the probable quantity the County will use. Commodities/Services will be ordered on an as-needed basis.

4.11 Wage Scale: In accordance with The Texas Government Code, Title 10, Chapter 2258, Prevailing Wage Rates, the general prevailing wage rate has been determined for this locality for the craft or type of workman needed to execute work of a similar character of the project listed herein. The Contractor shall pay the prevailing wage rate in this locality to all his/her employees and subcontractors performing work on this project, and in no event shall the Contractor pay less than the rate shown in the following schedule. Reference Attachment G for current prevailing wage rates.

4.12 Bonds: In accordance with V.T.C.A. 2253.021, a governmental agency that makes a public work contract with a prime contractor shall require the contractor, before beginning work, to execute to the governmental entity a Payment Bond if the contract is in excess of \$25,000.00 and a Performance Bond if the contract is in excess of \$100,000. Such bond shall be in the amount of the contract payable to the governmental entity and must be executed by a corporate surety in accordance with Section 1, Chapter 87, Acts of the 56th Legislature, Regular Session, 1959 (Article 7.19-1 Vernon's Texas Insurance Code).

4.13 Subcontractors: Contractor shall state names of all subcontractors and the type of work they will be performing on Attribute 4. If a Contractor fails to specify a subcontractor, then he shall be deemed to have agreed that he is fully qualified to perform the contract himself, and that he will fully perform the contract himself.

No Contractor whose bid is accepted shall (a) substitute any subcontractor, or (b) permit a subcontract to be voluntarily assigned or transferred or allow it to be performed by anyone other than the original subcontractor listed in the original bid without approval in writing from the Collin County Purchasing Department.

The successful Contractor further agrees that Collin County and its agents, servants and employees shall not be liable for any loss or damage resulting from personal injury, physical loss, harassment of or discrimination against employee or other violations of the provisions of this contract occasioned by the acts or omissions of the successful Contractor's subcontractors, their agents or employees. The indemnification provisions of this contract shall apply to all subcontractors.

4.14 Bid Documents: Contractor shall notify Collin County prior to bid if the bid documents are missing scope, incomplete or are contrary to actual site conditions.

4.15 Substitutions: All brand name materials in the following Scope of Work/Specifications and attachments is provided for descriptive purposes only. Collin County will consider equal brand materials. Bidders submitting a bid for all non-specified manufacturers shall submit with their bid, supporting documentation stating brand, model and the specifications of materials bid.

If bidder fails to submit supporting documentation, the County will assume bidder is bidding the exact brand and model as specified in this scope of work and if awarded a contract, contractor shall furnish same.

4.16 Execution of Contract: The person or persons, partnership, company, firm, association or corporation to whom a contract is awarded shall within ten (10) consecutive calendar days after such award, sign the necessary contract agreements and submit the required bonds entering into the required Contract with Owner. No contract shall be binding on Owner until it has been executed by Owner or his/her duly authorized representative, and delivered to the Contractor

4.17 Warranties: If within two (2) years after final acceptance of the work by Collin County, any of the work or material is found to be defective or not in accordance with the specifications of the contract, the contractor shall correct it promptly after receipt of a written notice from the County to do so. This obligation shall survive termination or completion of the contract. The County shall give such notice promptly after discovery of the condition.

If any materials or equipment utilized in this project are covered by a standard manufacturer's warranty greater than requirements specified herein, Contractor shall extend that coverage to Collin County.

The contractor shall remove from the site all portions of the work which are defective or nonconforming and which have not been corrected unless removal is waived in writing by the County.

4.18 Project Requirements and Clarifications:

4.18.1 Contractor is responsible for verifying actual dimensions, site conditions and materials required to provide a complete installation per the manufacturer's requirements.

4.18.2 Collin County shall not be responsible for contractor equipment or materials stored onsite.

4.18.3 Collin County shall not be responsible for the life safety or security of contractors or subcontractors employees.

4.18.4 Contractor shall be responsible for removal and disposal of all trash and removed materials. Contractor shall not use County dumpsters.

4.18.5 Contractor shall be responsible for all associated cost for removal and disposal of removed materials.

4.18.6 All work shall be scheduled with the following time and day restrictions: Monday through Friday from 8:00 AM to 3:00 PM.

4.18.7 Collin County employees shall not sign for or be responsible for material/equipment that is drop-shipped to the job site by the contractor.

4.19 Scope: Collin County is requesting the replacement of the metal roof on an approximately fifty (50) foot by seventy-five (75) foot building that meets at least the minimum specifications set forth below. Bid price shall include all materials and labor required for a completed installation per the manufacturer's recommendations. Refer to Attachment F for pictures of existing building.

4.20 Specifications:

4.20.1 Remove existing metal roof and haul off all removed materials.

4.20.2 Provide and install new metal roof and roof accessories including but not limited to screws, ridge cap, gable trim, eave trim, sealant tape, waterproofing sealant, pipe jacks and snow guards on the existing metal framing.

4.20.2.1 Fabral Mighti-Rib Metal Roofing Panels, or Collin County approved equal, color: galvanized. Refer to Attachment B.

4.20.2.2 Fabral Standard Mighti-Rib flashings and trims, or Collin County approved equal. Refer to Attachment C.

4.20.2.3 Fabral fasteners, or Collin County approved equal, color: galvanized. Refer to Attachment D

4.20.2.4 Fabral Snow Boss Snow Guards #640, or Collin County approved equal, to protect an eight (8) foot area above man door. Refer to Attachment E.

Public Works Weston Barn

McKinney, TX, United States

1.3 mi
Turn right onto N Central Expy toward Sherman

350 ft
Turn left to merge onto TX-121 N

11 mi
Take exit 48 toward FM-455, Anna-Weston Rd

0.3 mi
Turn left onto W FM 455 toward WESTON

4.1 mi
The destination is on your left

3821 W FM 455, Anna, TX 75409, United States



NORTH

WEST

EAST

75

937

285

827

284

915

367

SOUTH

Mighti-Rib®



NAIL PATTERN

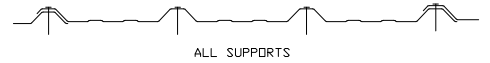

SCREW PATTERN

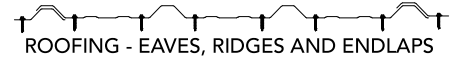

Please see Mighti-Rib specific trims on page 20

5V Crimp

USE ON SOLID DECKING

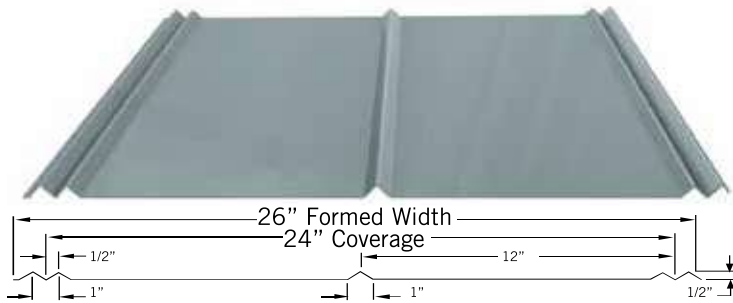

NAIL PATTERN



SCREW PATTERN

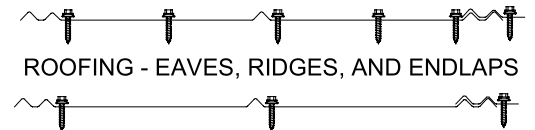

ProClad

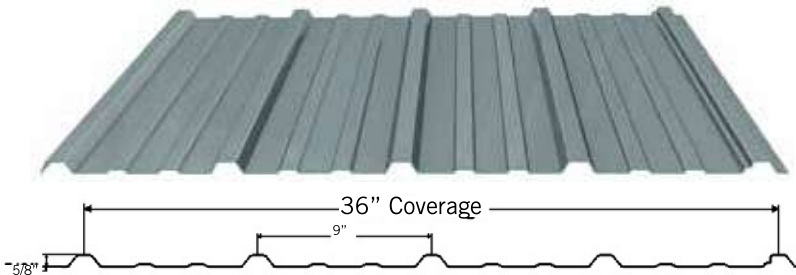

Sidelap Detail

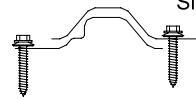

SCREW PATTERNS

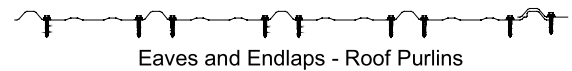

1 1/4" Corrugated

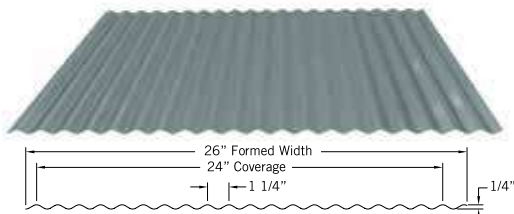

SCREW PATTERN

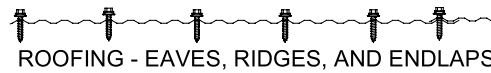

NAIL PATTERN

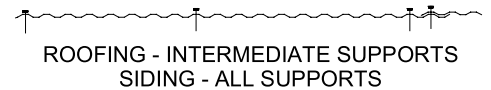
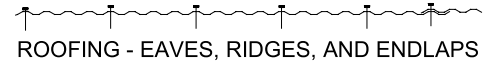

2 1/2" Corrugated

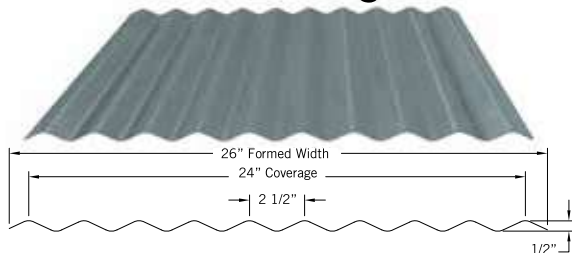

SCREW PATTERN



NAIL PATTERN

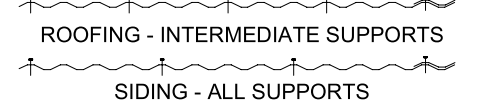
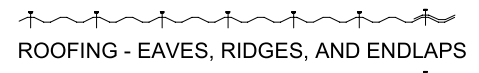

*Not all profiles are available in all areas. Please contact Fabral for availability

STANDARD MIGHTI-RIB®

FLASHINGS & TRIMS

All Mighti-Rib specific flashing is 10' 6" in length & available in steel, unless otherwise noted. Please contact Fabral for specifics on the trim available in your area.

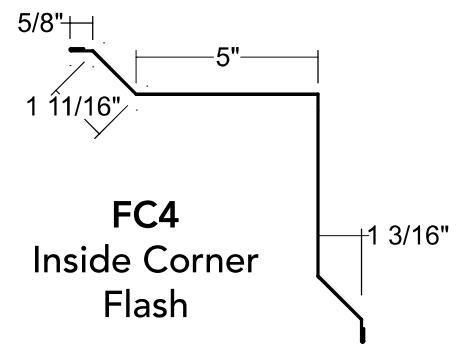
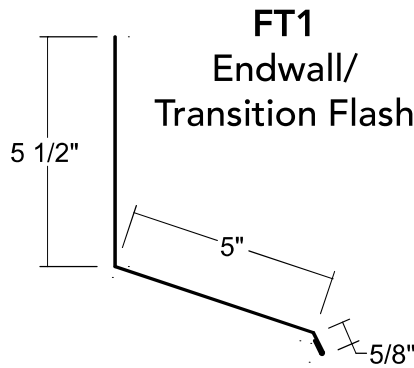
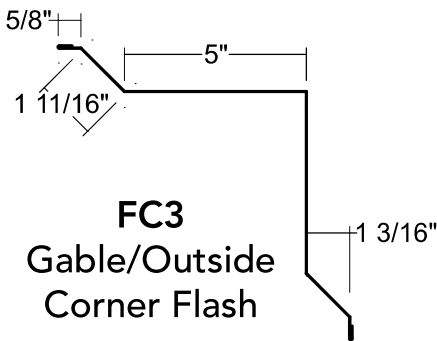
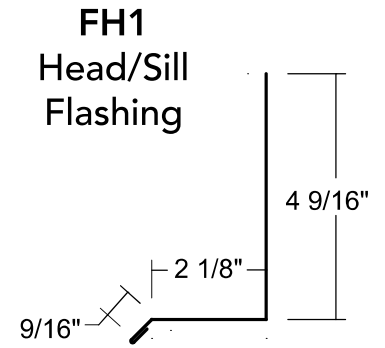
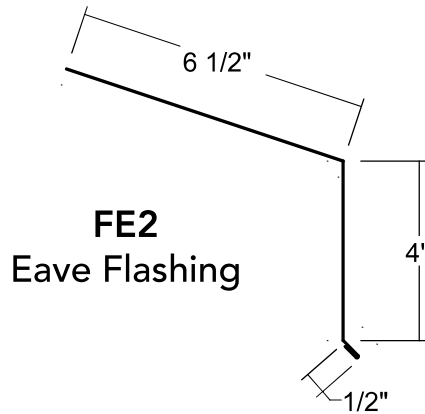
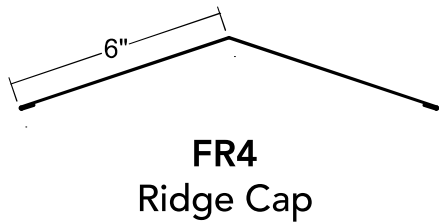

FJ4
Zee Flash

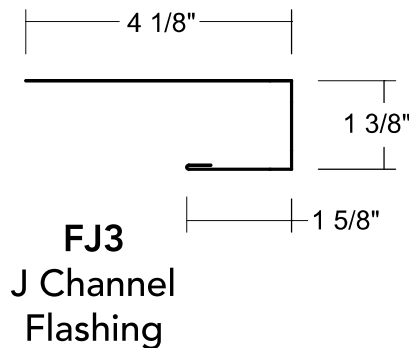
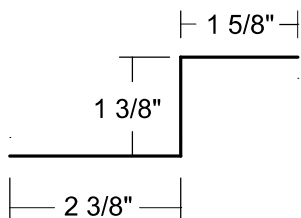

FASTENERS

For more information, review Fabral's installation manuals.

#9-16 WoodFast

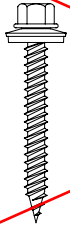

- Use with dimensional lumber
- Available in 1", 1 1/2", 2", 2 1/2" and 3"
- 1/4" hex head, EPDM/metal washer
- Oxyseal Long-Life Coating
- Plain or Painted
- 250/bag

#14-10 WoodTite

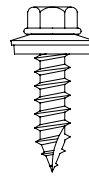

- Use to fasten metal to plywood or OSB
- Use for trim attachment
- Available in 1", 1 1/2", and 2"
- 5/16" hex head, EPDM/metal washer
- Oxyseal Long-Life Coating
- Plain or Painted
- 250/bag

#9-16 300 Series Stainless Steel

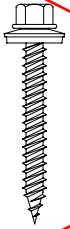

- Use for high corrosive environments
- Use with ALUMINUM panels
- Available in 1", 1 1/2", and 2"
- 1/4" hex head, EPDM/metal washer
- Use with treated lumber
- Plain or Painted
- 250/bag

#10-14 410 Stainless Steel

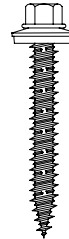

- Use with 26 gauge or thinner to avoid pre-drilling
- NOT as corrosive resistant as the 300 Series
- Steel is harder than 300 Series
- Available in 1", 1 1/2", and 2"
- 1/4" hex head, EPDM/metal washer
- Use with steel panels installed on treated lumber
- Plain or Painted
- 250/bag

#10-16 Ultimate WoodTite

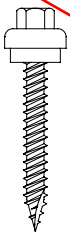

- Use with ALL panels
- Available in 1", 1 1/2", 2", 2 1/2" and 3"
- 5/16" case zinc hex head
- Hex head & washer all one piece
- Plain
- 250/bag

#12 x 3/4" Stitch Screw

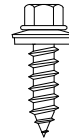

- Used for attachment of trim to top of seam for screw flange panels
- Use with STEEL panels
- Used to stitch sidelaps for exposed fastener panels
- Used for miscellaneous metal to metal attachments
- 1/4" hex head, EPDM/metal washer
- Plain or Painted
- 250/bag

UNDERLAYMENT

30-Year Peel & Stick PRODUCT SPECS:

- Watertight Self-Sealing Underlayment
- Asphalt-to-Asphalt Lap System
- Roll Size: 3' W x 72' L
- Minimum Thickness: 1.1mm
- Square Ft Per Roll: 200

50-Year Synthetic PRODUCT SPECS:

- Installation Requires mechanical fasteners
- Roll Size: 4' W x 250' L
- Minimum Thickness: .75mm
- Square Ft Per Roll: 1,000

30-Year Synthetic PRODUCT SPECS:

- Installation Requires mechanical fasteners
- Roll Size: 4' W x 250' L
- Minimum Thickness: .63mm
- Square Ft Per Roll: 1,000

25-Year Synthetic PRODUCT SPECS:

- Installation Requires mechanical fasteners
- Roll Size: 4' W x 250' L
- Minimum Thickness: .43mm
- Square Ft Per Roll: 1,000

SYSTEM COMPONENTS

SNOW GUARDS

Exposed Fastener Panel	MINI	CL	#640	#20	SM
Grandrib 3®	X	X	X		X
Mighti-Rib®	X	X	X		X
MP Panel™	X	X	X		X
5V Crimp	X	X	X		X
2 1/2" Corrugated				X	
ProClad	X	X	X		X



MINI Clear Snow Guard

- Available in premium polycarbonate plastic with UV stabilizers
- Provides maximum protection at a moderate price point
- Two-to-one base-to-blade ratio
- 4.5 sq.in. and gusseted blade snow pocket
- Typically installed by adhering to and mechanically fastened to the roofing panel



CL Snow Guard

- Available in premium polycarbonate plastic with UV stabilizers
- Unique vent rib systems allows for adhesive out gassing
- Three-to-one base-to-blade ratio adds significantly to strength



Snow Boss Snow Guards (#640)

- "Traditional Shape" solid cast aluminum
- Applied to the mid-panel on all standing, batten and flat seam roofs
- Typically installed by adhering to and mechanically fastened to the roofing panel
- Low profile protection, ideal for 1" x 2" purlins
- Non-Stock item, inquire for lead time



SM Snow Guard

- Available in cast aluminum
- Typically installed by adhering to and mechanically fastened to the roofing panel
- Very effective where there are no suitable seams
- Non-Stock item, inquire for lead time





Attachment G-Prevailing Wage Rates

General Decision Number: TX160289 05/06/2016 TX289

Superseded General Decision Number: TX20150289

State: Texas

Construction Type: Building

County: Collin County in Texas.

BUILDING CONSTRUCTION PROJECTS (does not include single family homes or apartments up to and including 4 stories).

Note: Under Executive Order (EO) 13658, an hourly minimum wage of \$10.15 for calendar year 2016 applies to all contracts subject to the Davis-Bacon Act for which the solicitation was issued on or after January 1, 2015. If this contract is covered by the EO, the contractor must pay all workers in any classification listed on this wage determination at least \$10.15 (or the applicable wage rate listed on this wage determination, if it is higher) for all hours spent performing on the contract in calendar year 2016. The EO minimum wage rate will be adjusted annually. Additional information on contractor requirements and worker protections under the EO is available at www.dol.gov/whd/govcontracts.

Modification Number	Publication Date
0	01/08/2016
1	01/15/2016
2	03/18/2016
3	04/01/2016
4	05/06/2016

ASBE0021-011 05/01/2013

	Rates	Fringes
ASBESTOS WORKER/HEAT & FROST INSULATOR (Duct, Pipe and Mechanical System Insulation).....	\$ 21.52	7.15

BOIL0074-003 01/01/2014

	Rates	Fringes
BOILERMAKER.....	\$ 23.14	21.55

CARP1421-002 04/01/2016

	Rates	Fringes
MILLWRIGHT.....	\$ 26.60	8.65

ELEV0021-006 01/01/2016

	Rates	Fringes
ELEVATOR MECHANIC.....	\$ 38.01	29.985+a

Attachment G-Prevailing Wage Rates

FOOTNOTES: a - A. 6% under 5 years based on regular hourly rate for all hours worked. 8% over 5 years based on regular hourly rate for all hours worked.

New Year's Day, Memorial Day, Independence Day, Labor Day, Thanksgiving Day, the Friday after Thanksgiving Day, Christmas Day, and Veterans Day.

 ENGI0178-005 06/01/2014

	Rates	Fringes
POWER EQUIPMENT OPERATOR		
(1) Tower Crane.....	\$ 29.00	10.60
(2) Cranes with Pile Driving or Caisson Attachment and Hydraulic Crane 60 tons and above.....	\$ 28.75	10.60
(3) Hydraulic cranes 59 Tons and under.....	\$ 27.50	10.60

 IRON0263-005 06/01/2015

	Rates	Fringes
IRONWORKER (ORNAMENTAL AND STRUCTURAL).....	\$ 23.00	6.55

 * PLUM0100-005 05/01/2016

	Rates	Fringes
HVAC MECHANIC (HVAC Unit Installation Only).....	\$ 30.14	10.41
PIPEFITTER (Excludes HVAC Pipe Installation).....	\$ 30.14	10.41

 SUTX2014-015 07/21/2014

	Rates	Fringes
BRICKLAYER.....	\$ 21.06	0.00
CARPENTER, Excludes Drywall Hanging, Form Work, and Metal Stud Installation.....	\$ 15.78	0.00
CAULKER.....	\$ 15.16	0.00
CEMENT MASON/CONCRETE FINISHER...	\$ 13.04	0.00
DRYWALL HANGER AND METAL STUD INSTALLER.....	\$ 13.00	0.00
ELECTRICIAN (Alarm Installation Only).....	\$ 20.93	3.86

Attachment G-Prevailing Wage Rates

ELECTRICIAN (Communication Technician Only).....	\$ 15.35	1.39
ELECTRICIAN (Low Voltage Wiring Only).....	\$ 17.04	1.39
ELECTRICIAN, Excludes Low Voltage Wiring and Installation of Alarms/Sound and Communication Systems.....	\$ 20.01	2.69
FORM WORKER.....	\$ 11.89	0.00
GLAZIER.....	\$ 16.46	3.94
HIGHWAY/PARKING LOT STRIPING: Operator (Striping Machine).....	\$ 10.04	2.31
INSTALLER - SIDING (METAL/ALUMINUM/VINYL).....	\$ 14.74	0.00
INSTALLER - SIGN.....	\$ 15.50	0.00
INSULATOR - BATT.....	\$ 13.00	0.00
IRONWORKER, REINFORCING.....	\$ 12.29	0.00
LABORER: Common or General.....	\$ 10.52	0.00
LABORER: Mason Tender - Brick...	\$ 10.54	0.00
LABORER: Mason Tender - Cement/Concrete.....	\$ 10.93	0.00
LABORER: Pipelayer.....	\$ 13.00	0.35
LABORER: Plaster Tender.....	\$ 12.22	0.00
LABORER: Roof Tearoff.....	\$ 11.28	0.00
LABORER: Landscape and Irrigation.....	\$ 10.55	0.00
LATHER.....	\$ 16.00	0.00
OPERATOR: Backhoe/Excavator/Trackhoe.....	\$ 12.83	0.00
OPERATOR: Bobcat/Skid Steer/Skid Loader.....	\$ 13.93	0.00
OPERATOR: Bulldozer.....	\$ 18.29	1.31
OPERATOR: Drill.....	\$ 15.69	0.50
OPERATOR: Forklift.....	\$ 13.21	0.81

Attachment G-Prevailing Wage Rates

OPERATOR: Grader/Blade.....	\$ 13.03	0.00
OPERATOR: Loader.....	\$ 13.46	0.85
OPERATOR: Mechanic.....	\$ 17.52	3.33
OPERATOR: Paver (Asphalt, Aggregate, and Concrete).....	\$ 18.44	0.00
OPERATOR: Roller.....	\$ 15.04	0.00
PAINTER (Brush, Roller and Spray), Excludes Drywall Finishing/Taping.....	\$ 13.35	5.10
PAINTER: Drywall Finishing/Taping Only.....	\$ 14.24	3.83
PIPEFITTER (HVAC Pipe Installation Only).....	\$ 20.45	4.00
PLASTERER.....	\$ 16.58	0.00
PLUMBER, Excludes HVAC Pipe Installation.....	\$ 22.46	4.06
ROOFER.....	\$ 17.19	0.00
SHEET METAL WORKER (HVAC Duct Installation Only).....	\$ 21.13	4.79
SHEET METAL WORKER, Excludes HVAC Duct Installation.....	\$ 24.88	5.97
SPRINKLER FITTER (Fire Sprinklers).....	\$ 37.50	0.00
TILE FINISHER.....	\$ 11.22	0.00
TILE SETTER.....	\$ 14.25	0.00
TRUCK DRIVER: 1/Single Axle Truck.....	\$ 16.00	0.81
TRUCK DRIVER: Dump Truck.....	\$ 12.39	1.18
TRUCK DRIVER: Flatbed Truck.....	\$ 19.65	8.57
TRUCK DRIVER: Semi-Trailer Truck.....	\$ 12.50	0.00
TRUCK DRIVER: Water Truck.....	\$ 12.00	4.11

WELDERS - Receive rate prescribed for craft performing operation to which welding is incidental.

Attachment G-Prevailing Wage Rates

=====
Unlisted classifications needed for work not included within the scope of the classifications listed may be added after award only as provided in the labor standards contract clauses (29CFR 5.5 (a) (1) (ii)).

The body of each wage determination lists the classification and wage rates that have been found to be prevailing for the cited type(s) of construction in the area covered by the wage determination. The classifications are listed in alphabetical order of "identifiers" that indicate whether the particular rate is a union rate (current union negotiated rate for local), a survey rate (weighted average rate) or a union average rate (weighted union average rate).

Union Rate Identifiers

A four letter classification abbreviation identifier enclosed in dotted lines beginning with characters other than "SU" or "UAVG" denotes that the union classification and rate were prevailing for that classification in the survey. Example:

PLUM0198-005 07/01/2014. PLUM is an abbreviation identifier of the union which prevailed in the survey for this classification, which in this example would be Plumbers. 0198 indicates the local union number or district council number where applicable, i.e., Plumbers Local 0198. The next number, 005 in the example, is an internal number used in processing the wage determination. 07/01/2014 is the effective date of the most current negotiated rate, which in this example is July 1, 2014.

Union prevailing wage rates are updated to reflect all rate changes in the collective bargaining agreement (CBA) governing this classification and rate.

Survey Rate Identifiers

Classifications listed under the "SU" identifier indicate that no one rate prevailed for this classification in the survey and the published rate is derived by computing a weighted average rate based on all the rates reported in the survey for that classification. As this weighted average rate includes all rates reported in the survey, it may include both union and non-union rates. Example: SULA2012-007 5/13/2014. SU indicates the rates are survey rates based on a weighted average calculation of rates and are not majority rates. LA indicates the State of Louisiana. 2012 is the year of survey on which these classifications and rates are based. The next number, 007 in the example, is an internal number used in producing the wage determination. 5/13/2014 indicates the survey completion date for the classifications and rates under that identifier.

Survey wage rates are not updated and remain in effect until a new survey is conducted.

Union Average Rate Identifiers

Attachment G-Prevailing Wage Rates

Classification(s) listed under the UAVG identifier indicate that no single majority rate prevailed for those classifications; however, 100% of the data reported for the classifications was union data. EXAMPLE: UAVG-OH-0010 08/29/2014. UAVG indicates that the rate is a weighted union average rate. OH indicates the state. The next number, 0010 in the example, is an internal number used in producing the wage determination. 08/29/2014 indicates the survey completion date for the classifications and rates under that identifier.

A UAVG rate will be updated once a year, usually in January of each year, to reflect a weighted average of the current negotiated/CBA rate of the union locals from which the rate is based.

WAGE DETERMINATION APPEALS PROCESS

1.) Has there been an initial decision in the matter? This can be:

- * an existing published wage determination
- * a survey underlying a wage determination
- * a Wage and Hour Division letter setting forth a position on a wage determination matter
- * a conformance (additional classification and rate) ruling

On survey related matters, initial contact, including requests for summaries of surveys, should be with the Wage and Hour Regional Office for the area in which the survey was conducted because those Regional Offices have responsibility for the Davis-Bacon survey program. If the response from this initial contact is not satisfactory, then the process described in 2.) and 3.) should be followed.

With regard to any other matter not yet ripe for the formal process described here, initial contact should be with the Branch of Construction Wage Determinations. Write to:

Branch of Construction Wage Determinations
Wage and Hour Division
U.S. Department of Labor
200 Constitution Avenue, N.W.
Washington, DC 20210

2.) If the answer to the question in 1.) is yes, then an interested party (those affected by the action) can request review and reconsideration from the Wage and Hour Administrator (See 29 CFR Part 1.8 and 29 CFR Part 7). Write to:

Wage and Hour Administrator
U.S. Department of Labor
200 Constitution Avenue, N.W.
Washington, DC 20210

The request should be accompanied by a full statement of the interested party's position and by any information (wage payment data, project description, area practice material, etc.) that the requestor considers relevant to the issue.

Attachment G-Prevailing Wage Rates

3.) If the decision of the Administrator is not favorable, an interested party may appeal directly to the Administrative Review Board (formerly the Wage Appeals Board). Write to:

Administrative Review Board
U.S. Department of Labor
200 Constitution Avenue, N.W.
Washington, DC 20210

4.) All decisions by the Administrative Review Board are final.

=====

END OF GENERAL DECISION

PAYMENT BOND

STATE OF TEXAS §
COUNTY OF COLLIN §

KNOW ALL MEN BY THESE PRESENTS:

That _____, a corporation organized and existing under the laws of the State of _____, and fully authorized to transact business in the State of Texas, whose address is _____ of the City of _____ County of _____, and State of _____, (hereinafter referred to as "Principal"), and _____ (hereinafter referred to as "Surety", a corporation organized under the laws of the State of _____ and authorized under the laws of the State of Texas to act as surety on bonds for principals, are held and firmly bound unto _____ (hereinafter referred to as "Owner") and unto all persons, firms and corporations who may furnish materials for or perform labor upon the buildings, structures or improvements referred to in the attached Contract, in the penal sum of _____ Dollars (\$ _____) (not less than 100% of the approximate total amount of the Contract as evidenced in the proposal) in lawful money of the United States, for the payment whereof, the said Principal and Surety bind themselves, and their heirs, administrators, executors, successors, and assigns, jointly and severally, firmly by these presents:

WHEREAS, the Principal has entered into a certain written contract with the Owner, dated the _____ day of _____, 20____, to which said Contract is hereby referred to and made a part hereof and as fully and to the same extent as if copied at length herein for the construction of _____.

NOW, THEREFORE, THE CONDITION OF THIS OBLIGATION IS SUCH, that the bond guarantees the full and proper protection of all claimants supplying labor and material in the prosecution of the work provided for in said Contract and for the use of each claimant, and that conversely should the Principal faithfully perform said Contract and in all respects duly and faithfully observe and perform all and singular the covenants, conditions, and agreements in and by said Contract, agreed to by the Principal, and according to the true intent and meaning of said Contract and the claims and specifications hereto annexed, and any and all duly authorized modifications of said Contract that may hereafter be made, notice of which modification to Surety being hereby waived, then this obligation shall be void; otherwise, to remain in full force and effect. Provided further, that if any legal action be filed on this Bond, venue shall lie in Collin County, Texas.

"PROVIDED, HOWEVER, that this bond is executed pursuant to the provisions Texas Government Code, Chapter 2253, as amended, and Chapter 3503 of the Texas Insurance Code, as amended, and all liabilities on this bond shall be determined in accordance with the provisions of said articles to the same extent as if they were fully copied at length herein.

Surety, for value received, stipulates and agrees that the bond shall automatically be increased by the amount of any Change Order or supplemental agreement which increases the Contract price with or without notice to the Surety and that no change, extension of time, alteration or addition to the terms of the Contract, or to the work performed thereunder, or the plans, specifications, or drawings accompanying the same, shall in anyway affect its obligation on this bond, and it does hereby waive notice of any such change, extension of time, alteration or addition to the terms of the Contract, or to the work to be performed thereunder.

The undersigned and designated agent is hereby designated by Surety herein as the agent resident to whom any requisite notice may be delivered and on whom service of process may be had in matters arising out of such suretyship.

IN WITNESS WHEREOF, the said Principal and Surety have signed and sealed this instrument this _____ day of _____ 20_____.

WITNESS

PRINCIPAL

Printed/Typed Name _____

Title: _____

Company: _____

Address: _____

SURETY

Printed/Typed Name _____

Title: _____

Company: _____

Address: _____

WITNESS

The Resident Agent of the Surety for delivery of notice and service of process is:
Name: _____
Address: _____
Phone Number: _____

Note: Date of Bond must NOT be prior to date of contract.

PERFORMANCE BOND

STATE OF TEXAS §
COUNTY OF COLLIN §

KNOW ALL MEN BY THESE PRESENTS:

That _____, a corporation organized and existing under the laws of the State of _____, and fully authorized to transact business in the State of Texas, whose address is _____ of the City of _____ County of _____, and State of _____, (hereinafter referred to as "Principal"), and _____ (hereinafter referred to as "Surety", a corporation organized under the laws of the State of _____ and authorized under the laws of the State of Texas to act as surety on bonds for principals, are held and firmly bound unto _____ (hereinafter referred to as "Owner") and unto all persons, firms and corporations who may furnish materials for or perform labor upon the buildings, structures or improvements referred to in the attached Contract, in the penal sum of _____ Dollars (\$ _____) (not less than 100% of the approximate total amount of the Contract as evidenced in the proposal plus 10-percent of the stated penal sum as an additional sum of money representing additional court expenses, attorneys' fees, and liquidated damages arising out of or connected with the below identified Contract) in lawful money of the United States, for the payment whereof, the said Principal and Surety bind themselves, and their heirs, administrators, executors, successors, and assigns, jointly and severally, firmly by these presents:

WHEREAS, the Principal has entered into a certain written contract with the Owner, dated the _____ day of _____, 20____, to which said Contract is hereby referred to and made a part hereof and as fully and to the same extent as if copied at length herein for the construction of _____.

NOW, THEREFORE, THE CONDITION OF THIS OBLIGATION IS SUCH, that if the said Principal fully and faithfully executes the work and performance of the Contract in accordance with the plans specifications, and Contract Documents, including any extensions thereof which may be granted with or without notice to Surety, during the original term thereof, and during the life of any guaranty required under the Contract, and according to the true intent and meaning of said Contract and the plans and specifications hereto annexed, if the Principal shall repair and/or replace all defects due to faulty materials or workmanship that appear within a period of one year from the date of final completion and final acceptance of the work by OWNER; and if the Principal shall fully indemnify and save harmless the OWNER from all costs and damages which OWNER may suffer by reason of failure to so perform herein and shall fully reimburse and repay OWNER all outlay and expense which the OWNER may incur in making good any default or deficiency, then this obligation shall be void; otherwise, to remain in full force and effect; and in case said CONTRACTOR shall fail to do so, it is agreed that the OWNER may do said work and supply such materials and charge the same against said CONTRACTOR and Surety on this obligation. Provided further, that if any legal action be filed on this Bond, venue shall lie in _____ Collin County, Texas.

"PROVIDED, HOWEVER, that this bond is executed pursuant to the provisions Texas Government Code, Chapter 2253, as amended, and Chapter 3503 of the Texas Insurance Code, as amended, and all liabilities on this bond shall be determined in accordance with the provisions of said articles to the same extent as if they were fully copied at length herein.

Surety, for value received, stipulates and agrees that the bond shall automatically be increased by the amount of any Change Order or supplemental agreement which increases the Contract price with or without notice to the Surety, but in no event shall a Change Order or Supplemental Agreement which reduces the Contract price decrease the penal sum of the Bond. And further that no change, extension of time, alteration, or addition to the terms of the Contract, or to the work performed thereunder, or the plans, specifications, or drawings accompanying the same shall in any way affect its obligation on this bond, and it does hereby waive notice of any such change, extension of time, alteration, or addition to the terms of the Contract or to the work to be performed thereunder.

Surety agrees that the bond provides for the repairs and/or replacement of all defects due to faulty materials and workmanship that appear within a period of one (1) year from the date of completion and acceptance of the improvement by the OWNER.

The undersigned and designated agent is hereby designated by Surety herein as the agent resident to whom any requisite notice may be delivered and on whom service of process may be had in matters arising out of such suretyship.

IN WITNESS WHEREOF, the said Principal and Surety have signed and sealed this instrument this _____ day of _____ 20_____.

WITNESS

PRINCIPAL

Printed/Typed Name _____
Title: _____
Company: _____
Address: _____

WITNESS

SURETY

Printed/Typed Name _____
Title: _____
Company: _____
Address: _____

The Resident Agent of the Surety for delivery of notice and service of process is:
Name: _____
Address: _____
Phone Number: _____

Note: Date of Bond must NOT be prior to date of contract.

CONSTRUCTION CONTRACT

This FIXED PRICE CONSTRUCTION CONTRACT BETWEEN OWNER AND CONTRACTOR (the "Contract") is made and entered into by and between COLLIN COUNTY, a political subdivision of the State of Texas (the "Owner") and _____ (the "Contractor"). This Contract is executed under seal, and shall be effective on _____ ("Effective Date"). This Contract is for the construction of a project identified as _____ (the "Project").

NOW, THEREFORE, in consideration of the mutual promises, covenants and agreements stated herein, and for other good and valuable consideration, the sufficiency of which is hereby acknowledged, the parties agree:

1. DOCUMENTS INCORPORATED BY REFERENCE

This Contract includes the plans and specifications for the Project identified thereon as such, plus the following (if any): _____

_____, all of which are hereby incorporated herein by reference and made a part hereof. Change Orders issued hereafter, and any other amendments executed by the Owner and the Contractor, shall become and be a part of this Contract. Documents not included or expressly contemplated in this Paragraph 1 do not, and shall not, form any part of this Contract. **Notwithstanding, no deviations in the Contractor's Executed Bid form from the Invitation to Bid, Construction Plans or other Contract documents prepared by the County shall be incorporated herein unless expressly provided in this Contract. Any conflict with the Contractor's Executed Bid Form and the Invitation to Bid, Construction Plans and other contract documents prepared by the County shall be construed in favor of the contract documents prepared by the County.**

2. REPRESENTATIONS OF THE CONTRACTOR

In order to induce the Owner to execute this Contract and recognizing that the Owner is relying thereon, the Contractor, by executing this Contract, makes the following express representations to the Owner:

(A) The Contractor is fully qualified to act as the contractor for the Project and has, and shall maintain, any and all licenses, permits or other authorizations necessary to act as the contractor for, and to construct, the Project;

(B) The Contractor has become familiar with the Project site and the local conditions under which the Project is to be constructed and operated;

(C) The Contractor has received, reviewed and carefully examined all of the documents which make up this Contract, including, but not limited to, the plans and specifications, and has found them in all respects to be complete, accurate, adequate, consistent, coordinated and sufficient for construction.

(D) Contractor warrants good right and title to all material, supplies, and equipment installed or incorporated in the work and agrees upon completion of all work to deliver to Owner all material, supplies, and equipment installed or incorporated in the work constructed free of any claims, liens, or charges.

3. INTENT AND INTERPRETATION

With respect to the intent and interpretation of this Contract, the Owner and the Contractor agree as follows:

(A) This Contract, together with the Contractor's and Surety's Payment, Performance Bonds, and Maintenance Bonds for the Project, if any, constitute the entire and exclusive agreements between the parties with reference to the

Project, and said Contract supersedes any and all prior discussions, communications, representations, understandings, negotiations, or agreements. This Contract also supersedes any bid documents;

(B) Anything that may be required, implied or inferred by the documents which make up this Contract, or any one or more of them, shall be provided by the Contractor for the Contract Price;

(C) Nothing contained in this Contract shall create, nor be interpreted to create, privity or any other relationship whatsoever between the Owner and any person except the Contractor;

(D) When a word, term, or phrase is used in this Contract, it shall be interpreted or construed first, as defined herein; second, if not defined, according to its generally accepted meaning in the construction industry; and third, if there is no generally accepted meaning in the construction industry, according to its common and customary usage;

(E) The words "include", "includes", or "including", as used in this Contract, shall be deemed to be followed by the phrase, "without limitation";

(F) The specification herein of any act, failure, refusal, omission, event, occurrence or condition as constituting a material breach of this Contract shall not imply that any other, non-specified act, failure, refusal, omission, event, occurrence or condition shall be deemed not to constitute a material breach of this Contract;

(G) The Contractor shall have a continuing duty to read, examine, review, compare and contrast each of the documents which make up this Contract, shop drawings, and other submittals and shall give written notice to the Owner of any conflict, ambiguity, error or omission which the Contractor may find with respect to these documents before proceeding with the affected work. The express or implied approval by the Owner of any shop drawings or other submittals shall not relieve the Contractor of the continuing duties imposed hereby, nor shall any such approval be evidence of the Contractor's compliance with this Contract. The Owner has prepared, or had someone prepare, documents for the Project, including the plans and specifications for the Project, which are accurate, adequate, consistent, coordinated and sufficient for construction. HOWEVER, THE OWNER MAKES NO REPRESENTATION OR WARRANTY OF ANY NATURE WHATSOEVER TO THE CONTRACTOR CONCERNING SUCH DOCUMENTS. The Contractor again hereby acknowledges and represents that it has received, reviewed and carefully examined such documents, has found them to be complete, accurate, adequate, consistent, coordinated and sufficient for construction, and that the Contractor has not, does not, and will not rely upon any representations or warranties by the Owner concerning such documents, as no such representations or warranties have been or are hereby made;

(H) In the event of any conflict, discrepancy, or inconsistency among any of the documents which make up this Contract, the following shall control:

- (1) As between figures given on plans and scaled measurements, the figures shall govern;
- (2) As between large scale plans and small scale plans, the large scale plans shall govern;
- (3) As between plans and specifications, the requirements of the specifications shall govern;
- (4) As between this document and the plans or specifications, this document shall govern.

(I) The Owner's representative shall be the project manager.

4. OWNERSHIP OF THE DOCUMENTS WHICH MAKE UP THE CONTRACT

The documents which make up this Contract, and each of them, as well as any other documents furnished by the Owner, shall remain the property of the Owner. The Contractor shall have the right to keep one (1) copy of the Contract upon completion of the Project; provided, however, that in no event shall the Contractor use, or permit to be used, any portion or all of such Contract on other projects without the Owner's prior written authorization.

5. CONTRACTOR'S PERFORMANCE

The Contractor shall perform all of the work required, implied or reasonably inferable from this Contract including, but not limited to, the following:

(A) Construction of the Project;

(B) The furnishing of any required surety bonds and insurance;

(C) The provision or furnishing, and prompt payment therefor, of labor, supervision, services, materials, supplies, equipment, fixtures, appliances, facilities, tools, transportation, storage, power, fuel, heat, light, cooling, or other utilities, required for construction and all necessary building permits and other permits required for the construction of the Project; and

(D) The creation and submission to the Owner of detailed and comprehensive as-built drawings depicting all as-built construction. Said as-built drawings shall be submitted to the Owner upon final completion of the Project and receipt and approval of same by the Owner shall be a condition precedent to final payment to the Contractor.

6. TIME FOR CONTRACTOR'S PERFORMANCE

(A) The Contractor shall commence the performance of this Contract on _____ and shall diligently continue its performance to and until final completion of the Project. The Contractor shall accomplish Substantial Completion of the Project on or before _____ (_____) days from notice to proceed;

(B) The Contractor shall pay the Owner the sum of _____ Zero _____ (\$0.00) per day for each and every calendar day of unexcused delay in achieving Substantial Completion beyond the date set forth herein for Substantial Completion. Any sums due and payable hereunder by the Contractor shall be payable, not as a penalty, but as liquidated damages representing an estimate of delay damages likely to be sustained by the Owner, estimated at the time of executing this Contract. When the Owner reasonably believes that Substantial Completion will be inexcusably delayed, the Owner shall be entitled, but not required, to withhold from any amounts otherwise due the Contractor an amount then believed by the Owner to be adequate to recover liquidated damages applicable to such delays. If and when the Contractor overcomes the delay in achieving Substantial Completion, or any part thereof, for which the Owner has withheld payment, the Owner shall promptly release to the Contractor those funds withheld, but no longer applicable, as liquidated damages;

(C) The term "Substantial Completion", as used herein, shall mean that point at which the Project is at a level of completion in strict compliance with this Contract such that the Owner or its designee can enjoy beneficial use or occupancy and can use or operate it in all respects, for its intended purpose. Partial use or occupancy of the Project shall not result in the Project being deemed substantially complete, and such partial use or occupancy shall not be evidence of Substantial Completion;

(D) All limitations of time set forth herein are material and are of the essence of this Contract.

7. FIXED PRICE AND CONTRACT PAYMENTS

(A) The Owner shall pay, and the Contractor shall accept, as full and complete payment for the Contractor's timely performance of its obligations hereunder the fixed price of _____ Dollars (\$_____). The price set forth in this Subparagraph 7(A) shall constitute the Contract Price, which shall not be modified except by Change Order as provided in this Contract.

This fixed price above is based on the quantities indicated based on the actual scope of the project as shown on the construction plans. Should the quantities of any of the items of the work as listed in the executed Proposal and Bid Form be increased, the Contractor shall perform the additional work at the unit bid prices submitted.

Should the quantities of any of the items of the work as listed in the executed Proposal and Bid Form be decreased, the Fixed Price shall be reduced accordingly based on the above unit bid prices and the Contractor shall make no claim for anticipated profits or lost overhead for any decrease in quantities. Payments will be made on actual quantities installed, as measured in place;

(B) Within ten (10) calendar days of the effective date hereof, the Contractor shall prepare and present to the Owner the Contractor's Schedule of Values apportioning the Contract Price among the different elements of the Project for purposes of periodic and final payment. The Contractor's Schedule of Values shall be presented in whatever format, with such detail, and backed up with whatever supporting information the Owner requests. The Contractor shall not imbalance its Schedule of Values nor artificially inflate any element thereof. The violation of this provision by the Contractor shall constitute a material breach of this Contract. The Contractor's Schedule of Values will be utilized for the Contractor's Payment Requests but shall only be so utilized after it has been acknowledged in writing by the Owner;

(C) The Owner shall pay the Contract Price to the Contractor in accordance with the procedures set forth in this Paragraph 7. On or before the 1st day of each month after commencement of performance, but no more frequently than once monthly, the Contractor may submit a Payment Request for the period ending the 25th day of the month to the following:

Bill Burke
Building Projects Manager
Collin County Construction and Projects
4600 Community Ave.
McKinney, TX 75071

In accordance with the Texas Prompt Payment Act and the Owner's receipt of a properly submitted and correct Application for Payment, and the issuance of a Certificate for Payment, the Owner shall make payment to the Contractor, in the amount approved by the Owner less 5% retainage. Such payment shall be adjusted for work that is incomplete or not in accordance with the Contract Documents, or that is the subject of a separate contract, or subcontract or supplier claim or lien against the Contractor or the payment bonds for the project. Notwithstanding anything herein to the contrary, Contractor shall not be paid for equipment and materials until after installation.

Each such Payment Request shall be signed by the Contractor and shall constitute the Contractor's representation that the quantity of work has reached the level for which payment is requested, that the work has been properly installed or performed in strict compliance with this Contract, and that the Contractor knows of no reason why payment should not be made as requested. Thereafter, the Owner shall review the Payment Request and may also review the work at the Project site or elsewhere to determine whether the quantity and quality of the work is as represented in the Payment Request and is as required by this Contract. The Owner shall approve in writing the amount which, in the opinion of the Owner, is properly owing to the Contractor. The amount of each such payment shall be the amount approved for payment by the Owner less such amounts, if any, otherwise owing by the Contractor to the Owner or which the Owner shall have the right to withhold as authorized by this Contract. The submission by the Contractor of a Payment Request also constitutes an affirmative representation and warranty that all work for which the Owner has previously paid is free and clear of any lien, claim, or other encumbrance from subcontractors, materialmen, suppliers and other person or entity who has, or might have a claim against the Owner for the work done on the Owner's property. Furthermore, the Contractor warrants and represents that, upon payment of the Payment Request submitted, title to all work included in such payment shall be vested in the Owner;

(D) When payment is received from the Owner, the Contractor shall immediately pay all subcontractors, materialmen, laborers and suppliers the amounts they are due for the work covered by such payment. In the event the Owner becomes informed that the Contractor has not paid a subcontractor, materialman, laborer, or supplier within 10 days after the Contractor's receipt of payment, the Owner shall have the right, but not the duty, to issue future checks and payment to the Contractor of amounts otherwise due hereunder naming the Contractor and any such subcontractor, materialman, laborer, or supplier as joint payees. Such joint check procedure, if employed by the Owner, shall create no rights in favor of any person or entity beyond the right of the named payees to payment of the check and shall not be deemed to commit the Owner to repeat the procedure in the future;

(E) Neither payment to the Contractor, utilization of the Project for any purpose by the Owner, nor any other act or omission by the Owner shall be interpreted or construed as an acceptance of any work of the Contractor not strictly in compliance with this Contract;

(F) The Owner shall have the right to refuse to make payment and, if necessary, may demand the return of a portion or all of the amount previously paid to the Contractor due to:

(1) The quality of a portion, or all, of the Contractor's work not being in accordance with the requirements of this Contract;

(2) The quantity of the Contractor's work not being as represented in the Contractor's Payment Request, or otherwise;

(3) The Contractor's rate of progress being such that, in the Owner's opinion, Substantial Completion or final completion, or both, may be inexcusably delayed;

(4) The Contractor's failure to use Contract funds, previously paid the Contractor by the Owner, to pay Contractor's Project-related obligations including, but not limited to, subcontractors, laborers and material and equipment suppliers;

(5) Claims made, or likely to be made, against the Owner or its property;

(6) Loss caused by the Contractor;

(7) The Contractor's failure or refusal to perform any of its obligations to the Owner. In the event that the Owner makes written demand upon the Contractor for amounts previously paid by the Owner as contemplated in this Subparagraph 7(F), the Contractor shall promptly comply with such demand;

(G) If within thirty (30) days from the date payment to the Contractor is due, the Owner, without cause or basis hereunder, fails to pay the Contractor any amounts then due and payable to the Contractor, the Contractor shall have the right to cease work until receipt of proper payment after first providing ten (10) days' written notice of its intent to cease work to the Owner.

(H) When Substantial Completion has been achieved, the Contractor shall notify the Owner in writing and shall furnish to the Owner a proposed punch list listing of those matters yet to be finished. The Owner will thereupon conduct an inspection to confirm that the work is in fact substantially complete and shall upon determining that the work is substantially complete, shall review and revise, if necessary, the proposed punch list. Upon its confirmation that the Contractor's work is substantially complete, the Owner will so notify the Contractor in writing and will therein set forth the date of Substantial Completion and furnish the final punch list of items that need to be completed for final completion. If the Owner, through its inspection, fails to find that the Contractor's work is substantially complete, and is required to repeat all, or any portion, of its Substantial Completion inspection, the Contractor shall bear the cost of such repeat inspection(s) which cost may be deducted by the Owner from any payment then or thereafter due to the Contractor. Guarantees and equipment warranties required by this Contract shall commence on the date of Substantial Completion. Upon Substantial Completion, the Owner shall pay the Contractor an amount sufficient to increase total payments to the Contractor to ninety percent (90%) of the Contract Price less any amounts attributable to liquidated damages, and less the reasonable costs as determined by the Owner for completing all incomplete work, correcting and bringing into conformance all defective and nonconforming work, and handling any outstanding or threatened claims;

(I) When the Project is finally complete and the Contractor is ready for a final inspection, it shall notify the Owner thereof in writing. Thereupon, the Owner will perform a final inspection of the Project. If the Owner confirms that the Project is complete in full accordance with this Contract and that the Contractor has performed all of its obligations to the Owner hereunder, the Owner will furnish a final Approval for Payment and the Contractor is entitled to the remainder of the unpaid Contract Price, less any amount withheld pursuant to this Contract. If the Owner is unable to issue its final Approval for Payment and is required to repeat its final inspection of the Project, the Contractor shall bear the cost of such repeat inspection(s), which costs may be deducted by the Owner from the Contractor's final payment;

(J) If the Contractor fails to achieve final completion within 30 days of (i) Substantial Completion, or (ii) the Owner's delivery to the Contractor of the punch list described in Subparagraph 7(H) herein, whichever is later, the

Contractor shall pay the Owner the sum of Zero Dollars (\$0.00) per day for each and every calendar day of unexcused delay in achieving final completion beyond the date set forth herein for final completion of the work. Any sums due and payable hereunder by the Contractor shall be payable, not as a penalty, but as liquidated damages representing an estimate of delay damages likely to be sustained by the Owner, estimated at or before the time of executing this Contract. When the Owner reasonably believes that final completion will be inexcusably delayed, the Owner shall be entitled, but not required, to withhold from any amounts otherwise due the Contractor an amount then believed by the Owner to be adequate to recover liquidated damages applicable to such delays. If and when the Contractor overcomes the delay in achieving final completion, or any part thereof, for which the Owner has withheld payment, the Owner shall promptly release to the Contractor those funds withheld, but no longer applicable, as liquidated damages;

(K) Prior to being entitled to receive final payment, and as a condition precedent thereto, the Contractor shall furnish the Owner, in the form and manner required by Owner, if any:

- (1) An affidavit that all of the Contractor's obligations to subcontractors, laborers, equipment or material suppliers, or other third parties in connection with the Project, have been paid or otherwise satisfied;
- (2) If applicable, consent(s) of surety to final payment;
- (3) All product warranties, operating manuals, instruction manuals and other record documents, drawings (including as-built drawings), satisfactory test results and things customarily required of the Contractor, or expressly required herein or set forth in the bid documents, as a part of or prior to Project closeout;

(L) The final Certificate for Payment will not be issued until all such warranties and guaranties have been received and accepted by the Owner, and a Certificate of Acceptance is issued.

8. INFORMATION AND MATERIAL SUPPLIED BY THE OWNER

(A) The Owner shall furnish to the Contractor, prior to the execution of this Contract, any and all written and tangible material in its possession concerning conditions below ground at the site of the Project. Such written and tangible material is furnished to the Contractor only in order to make complete disclosure of such material as being in the possession of the Owner and for no other purpose. By furnishing such material, the Owner does not represent, warrant, or guarantee its accuracy either in whole, in part, implicitly or explicitly, or at all, and shall have no liability therefor. The Owner shall also furnish, if appropriate, the legal description of the Project site, and any required survey;

(B) The Owner shall obtain all required authorizations, approvals, easements, and the like excluding the building permit and other permits or fees required of the Contractor by this Contract, or permits and fees customarily the responsibility of the Contractor;

(C) The Owner will provide the Contractor one (1) copy of the complete Contract. The Contractor will be charged, and shall pay the Owner, the actual cost of duplication for any additional copy of the Contract which it may require.

9. CEASE AND DESIST ORDER

In the event the Contractor fails or refuses to perform the work as required herein, the Owner may instruct the Contractor to cease and desist from performing further work in whole or in part. Upon receipt of such instruction, the Contractor shall immediately cease and desist as instructed by the Owner and shall not proceed further until the cause for the Owner's instructions has been corrected, no longer exists, or the Owner instructs that the work may resume. In the event the Owner issues such instructions to cease and desist, and in the further event that the Contractor fails and refuses within seven (7) days of receipt of same to provide adequate assurance to the Owner that the cause of such instructions will be eliminated or corrected, then the Owner shall have the right, but not the obligation, to carry out the work with its own forces, or with the forces of another contractor, and the Contractor shall be fully responsible and liable for the costs of performing such work by the Owner. The rights set forth herein are in addition to, and without prejudice to, any other rights or remedies the Owner may have against the Contractor.

10. DUTIES, OBLIGATIONS AND RESPONSIBILITIES OF THE CONTRACTOR

In addition to any and all other duties, obligations and responsibilities of the Contractor set forth in this Contract, the Contractor shall have and perform the following duties, obligations and responsibilities to the Owner:

(A) The Contractor is again reminded of its continuing duties set forth in Subparagraph 3(G), which are by reference hereby incorporated in this Subparagraph 10(A). The Contractor shall not perform work without adequate plans and specifications, or, as appropriate, approved shop drawings, or other submittals. If the Contractor performs work knowing or believing it involves an error, inconsistency or omission in the Contract without first providing written notice to the Owner, the Contractor shall be responsible for such work and pay the cost of correcting same;

(B) All work shall strictly conform to the requirements of this Contract;

(C) The work shall be strictly supervised, the Contractor bearing full responsibility for any and all acts or omissions of those engaged in the work on behalf of the Contractor;

(D) The Contractor hereby warrants that all labor furnished under this Contract shall be competent to perform the tasks undertaken, that the product of such labor shall yield only first-class results, that all materials and equipment provided shall be new and of high quality, that the completed work will be complete, of high quality, without defects, and that all work strictly complies with the requirements of this Contract. Any work not strictly complying with the requirements of this Subparagraph shall constitute a breach of the Contractor's warranty;

(E) The Contractor shall obtain and pay for all required permits, fees and licenses customarily obtained by the Contractor. The Contractor shall comply with all legal requirements applicable to the work;

(F) The Contractor shall employ and maintain at the Project site only competent supervisory personnel. Key supervisory personnel assigned by the Contractor to this Project are as follows:

NAME FUNCTION

_____	_____
_____	_____
_____	_____

So long as the individuals named above remain actively employed or retained by the Contractor, they shall perform the functions indicated next to their names unless the Owner agrees to the contrary in writing. In the event one or more individuals not listed above subsequently assumes one or more of those functions listed above, the Contractor shall be bound by the provisions of this Subparagraph 10(F) as though such individuals had been listed above;

(G) The Contractor, within fifteen (15) days of commencing the work, shall provide to the Owner, and comply with, the Contractor's schedule for completing the work. Such schedule shall be in a form acceptable to the Owner. The Contractor's schedule shall be updated no less frequently than monthly (unless the parties otherwise agree in writing) and shall be updated to reflect conditions encountered from time to time and shall apply to the total Project. Each such revision shall be furnished to the Owner. Strict compliance with the requirements of this Subparagraph 10(G) shall be a condition precedent to payment to the Contractor, and failure by the Contractor to strictly comply with said requirements shall constitute a material breach of this Contract;

(H) The Contractor shall keep an updated copy of this Contract at the site. Additionally, the Contractor shall keep a copy of approved shop drawings and other submittals. All of these items shall be available to the Owner at all regular business hours. Upon final completion of the work, all of these items shall be finally updated and provided to the Owner and shall become the property of the Owner;

(I) Shop drawings and other submittals from the Contractor do not constitute a part of the Contract. The Contractor shall not do any work requiring shop drawings or other submittals unless such shall have been approved in writing by the Owner. All work requiring approved shop drawings or other submittals shall be done in strict compliance

with such approved documents. However, approval by the Owner shall not be evidence that work installed pursuant thereto conforms to the requirements of this Contract. The Owner shall have no duty to review partial submittals or incomplete submittals. The Contractor shall maintain a submittal log which shall include, at a minimum, the date of each submittal, the date of any resubmittal, the date of any approval or rejection, and the reason for any approval or rejection. The Contractor shall have the duty to carefully review, inspect and examine any and all submittals before submission of same to the Owner;

(J) The Contractor shall maintain the Project site in a reasonably clean condition during performance of the work. Upon final completion, the Contractor shall thoroughly clean the Project site of all debris, trash and excess materials or equipment;

(K) At all times relevant to this Contract, the Contractor shall permit the Owner to enter upon the Project site and to review or inspect the work without formality or other procedure.

11. INDEMNITY

Contractor shall indemnify and hold the County, and its officers and employees, harmless from liabilities, damages, losses and costs, including, but not limited to, attorneys' fees, to the extent caused by the negligence, recklessness or intentional wrongful conduct of Contractor or other persons employed or utilized by Contractor in the performance of the Contract; provided however, that this indemnification shall be limited to the amount of this Contract.

12. NO DESIGN PROFESSIONAL

There is no architect or consulting engineer acting as Owner's agent including inspection of work or progress of Contractor in this contract. Accordingly, the Owner shall have the following duties and responsibilities:

(A) The Owner shall draft proposed Change Orders;

(B) The Owner shall approve, or respond otherwise as necessary concerning shop drawings or other submittals received from the Contractor;

(C) The Owner shall be authorized to refuse to accept work which is defective or otherwise fails to comply with the requirements of this Contract. If the Owner deems it appropriate, the Owner shall be authorized to call for extra inspection or testing of the work for compliance with requirements of this Contract;

(D) The Owner shall review the Contractor's Payment Requests and shall approve in writing those amounts which, in the opinion of the Owner, are properly owing to the Contractor as provided in this Contract;

(E) The Owner shall, upon written request from the Contractor, perform those inspections required in Paragraph 7 hereinabove;

13. CLAIMS BY THE CONTRACTOR

Claims by the Contractor against the Owner are subject to the following terms and conditions:

(A) All Contractor claims against the Owner shall be initiated by a written claim submitted to the Owner. Such claim shall be received by the Owner no later than seven (7) calendar days after the event, or the first appearance of the circumstances, causing the claim, and same shall set forth in detail all known facts and circumstances supporting the claim;

(B) The Contractor and the Owner shall continue their performance hereunder regardless of the existence of any claims submitted by the Contractor;

(C) In the event the Contractor discovers previously concealed and unknown site conditions which are materially at variance from those typically and ordinarily encountered in the general geographical location of the Project, the Contract Price shall be modified, either upward or downward, upon the written claim made by either party within seven (7) calendar days after the first appearance to such party of the circumstances. As a condition precedent to the Owner having any liability to the Contractor due to concealed and unknown conditions, the Contractor must give the Owner written notice of, and an opportunity to observe, such condition prior to disturbing it. The failure by the Contractor to give the written notice and make the claim as provided by this Subparagraph 13(C) shall constitute a waiver by the Contractor of any rights arising out of or relating to such concealed and unknown condition;

(D) In the event the Contractor seeks to make a claim for an increase in the Contract Price, as a condition precedent to any liability of the Owner therefor, the Contractor shall strictly comply with the requirements of Subparagraph 13(A) above and such claim shall be made by the Contractor before proceeding to execute any additional or changed work. Failure of the condition precedent to occur shall constitute a waiver by the Contractor of any claim for additional compensation;

(E) In connection with any claim by the Contractor against the Owner for compensation in excess of the Contract Price, any liability of the Owner for the Contractor's cost shall be strictly limited to direct cost incurred by the Contractor and shall in no event include indirect cost or consequential damages of the Contractor. The Owner shall not be liable to the Contractor for claims of third-parties including subcontractors, unless and until liability of the Contractor has been established therefor in a court of competent jurisdiction;

(F) In the event the Contractor should be delayed in performing any task which at the time of the delay is then critical, or which during the delay becomes critical, as the sole result of any act or omission by the Owner or someone acting in the Owner's behalf, or by Owner-authorized Change Orders, unusually bad weather not reasonably anticipatable, fire or other Acts of God, the date for achieving Substantial Completion, or, as applicable, final completion, shall be appropriately adjusted by the Owner upon the written claim of the Contractor to the Owner. A task is critical within the meaning of this Subparagraph 13(F) if, and only if, said task is on the critical path of the Project schedule so that a delay in performing such task will delay the ultimate completion of the Project. Any claim for an extension of time by the Contractor shall strictly comply with the requirements of Subparagraph 13(A) above. If the Contractor fails to make such claim as required in this Subparagraph 13(F), any claim for an extension of time shall be waived.

14. SUBCONTRACTORS

The Contractor shall identify to the Owner, in writing, those parties intended as subcontractors on the Project. The Owner shall, in writing, state any objections the Owner may have to one or more of such subcontractors. The Contractor shall not enter into a subcontract with an intended subcontractor with reference to whom the Owner objects. All subcontracts shall afford the Contractor rights against the subcontractor which correspond to those rights afforded to the Owner against the Contractor herein, including those rights of Contract termination as set forth herein below.

15. CHANGE ORDERS

One or more changes to the work within the general scope of this Contract may be ordered by Change Order. The Contractor shall proceed with any such changes, and same shall be accomplished in strict accordance with the following terms and conditions:

(A) Change Order shall mean a written order to the Contractor executed by the Owner after execution of this Contract, directing a change in the work and may include a change in the Contract Price or the time for the Contractor's performance, or any combination thereof;

(B) Any change in the Contract Price resulting from a Change Order shall be determined as follows:

(1) By mutual agreement between the Owner and the Contractor as evidenced by (a) the change in the Contract Price being set forth in the Change Order, (b) such change in the Contract Price, together with any conditions or

requirements relating thereto, being initialed by both parties and (c) the Contractor's execution of the Change Order, or,

(2) If no mutual agreement occurs between the Owner and the Contractor, the change in the Contract Price, if any, shall be derived by determining the reasonable actual costs incurred or savings achieved, resulting from revisions in the work. Such reasonable actual costs or savings shall include a component for direct jobsite overhead and profit but shall not include home-office overhead or other indirect costs or components. Any such costs or savings shall be documented in the format and with such content and detail as the Owner requires.

(C) The execution of a Change Order by the Contractor shall constitute conclusive evidence of the Contractor's agreement to the ordered changes in the work, this Contract as thus amended, the Contract Price and the time for performance by the Contractor. The Contractor, by executing the Change Order, waives and forever releases any claim against the Owner for additional time or compensation for matters relating to or arising out of or resulting from the work included within or affected by the executed Change Order;

(D) The Contractor shall notify and obtain the consent and approval of the Contractor's surety with reference to all Change Orders if such notice, consent or approvals are required by the Owner, the Contractor's surety or by law. The Contractor's execution of the Change Order shall constitute the Contractor's warranty to the Owner that the surety has been notified of, and consents to, such Change Order and the surety shall be conclusively deemed to have been notified of such Change Order and to have expressly consented thereto.

(E) The owner's representative in this agreement is the project manager. No change orders or other modifications to this agreement shall be effective unless in writing and signed by the Purchasing Agent.

16. DISCOVERING AND CORRECTING DEFECTIVE OR INCOMPLETE WORK

(A) In the event that the Contractor covers, conceals or obscures its work in violation of this Contract or in violation of a directive from the Owner, such work shall be uncovered and displayed for the Owner's inspection upon request, and shall be reworked at no cost in time or money to the Owner;

(B) If any of the work is covered, concealed or obscured in a manner not covered by Subparagraph 16(A) above, it shall, if directed by the Owner, be uncovered and displayed for the Owner's inspection. If the uncovered work conforms strictly to this Contract, the costs incurred by the Contractor to uncover and subsequently, replace such work shall be borne by the Owner. Otherwise, such costs shall be borne by the Contractor;

(C) The Contractor shall, at no cost in time or money to the Owner, correct work rejected by the Owner as defective or failing to conform to this Contract. Additionally, the Contractor shall reimburse the Owner for all testing, inspections and other expenses incurred as a result thereof;

(D) In addition to its warranty obligations set forth elsewhere herein, the Contractor shall be specifically obligated to correct any and all defective or nonconforming work for a period of twelve (12) months following final completion upon written direction from the Owner.

(E) The Owner may, but shall in no event be required to, choose to accept defective or nonconforming work. In such event, the Contract Price shall be reduced by the greater of (1) the reasonable costs of removing and correcting the defective or nonconforming work, and (2) the difference between the fair market value of the Project as constructed and the fair market value of the Project had it not been constructed in such a manner as to include defective or nonconforming work. If the remaining portion of the unpaid Contract Price, if any, is insufficient to compensate the Owner for the acceptance of defective or nonconforming work, the Contractor shall, upon written demand from the Owner, pay the Owner such remaining compensation for accepting defective or nonconforming work.

17. TERMINATION BY THE CONTRACTOR

If the Owner repeatedly fails to perform its material obligations to the Contractor for a period of thirty (30) days after receiving written notice from the Contractor of its intent to terminate hereunder, the Contractor may

terminate performance under this Contract by written notice to the Owner. In such event, the Contractor shall be entitled to recover from the Owner as though the Owner had terminated the Contractor's performance under this Contract for convenience pursuant to Subparagraph 19(A) hereunder.

18. OWNER'S RIGHT TO SUSPEND CONTRACTOR'S PERFORMANCE

(A) The Owner shall have the right at any time to direct the Contractor to suspend its performance, or any designated part thereof, for any reason whatsoever, or without reason, for a cumulative period of up to ten (10) calendar days. If any such suspension is directed by the Owner, the Contractor shall immediately comply with same;

(B) In the event the Owner directs a suspension of performance under this Paragraph 18, through no fault of the Contractor, the Owner shall pay the Contractor as full compensation for such suspension the Contractor's reasonable costs, actually incurred and paid, of:

- (1) demobilization and remobilization, including such costs paid to subcontractors;
- (2) preserving and protecting work in place;
- (3) storage of materials or equipment purchased for the Project, including insurance thereon;
- (4) performing in a later, or during a longer, time frame than that contemplated by this Contract.

19. TERMINATION BY THE OWNER

The Owner may terminate this Contract in accordance with the following terms and conditions:

(A) The Owner may, for any reason whatsoever, terminate performance under this Contract by the Contractor for convenience. The Owner shall give written notice of such termination to the Contractor specifying when termination becomes effective. The Contractor shall incur no further obligations in connection with the work and the Contractor shall stop work when such termination becomes effective. The Contractor shall also terminate outstanding orders and subcontracts. The Contractor shall settle the liabilities and claims arising out of the termination of subcontracts and orders. The Owner may direct the Contractor to assign the Contractor's right, title and interest under termination orders or subcontracts to the Owner or its designee. The Contractor shall transfer title and deliver to the Owner such completed or partially completed work and materials, equipment, parts, fixtures, information and Contract rights as the Contractor has. When terminated for convenience, the Contractor shall be compensated as follows:

- (1) The Contractor shall submit a termination claim to the Owner specifying the amounts due because of the termination for convenience together with costs, pricing or other data required by the Owner. If the Contractor fails to file a termination claim within one (1) year from the effective date of termination, the Owner shall pay the Contractor, an amount derived in accordance with Subparagraph (3) below;
- (2) The Owner and the Contractor may agree to the compensation, if any, due to the Contractor hereunder;
- (3) Absent agreement to the amount due to the Contractor, the Owner shall pay the Contractor the following amounts:
 - (a) Contract prices for labor, materials, equipment and other services accepted under this Contract;
 - (b) Reasonable costs incurred in preparing to perform and in performing the terminated portion of the work, and in terminating the Contractor's performance, plus a fair and reasonable allowance for direct jobsite overhead and profit thereon (such profit shall not include anticipated profit or consequential damages); provided however, that if it appears that the Contractor would have not profited or would have sustained a loss if the entire Contract would have been completed, no profit shall be allowed or included and the amount of compensation shall be reduced to reflect the anticipated rate of loss, if any;

(c) Reasonable costs of settling and paying claims arising out of the termination of subcontracts or orders pursuant to Subparagraph 19(A) of this Paragraph. These costs shall not include amounts paid in accordance with other provisions hereof.

The total sum to be paid the Contractor under this Subparagraph 19(A) shall not exceed the total Contract Price, as properly adjusted, reduced by the amount of payments otherwise made, and shall in no event include duplication of payment.

(B) If the Contractor does not perform the work, or any part thereof, in a timely manner, supply adequate labor, supervisory personnel or proper equipment or materials, or if it fails to timely discharge its obligations for labor, equipment and materials, or proceeds to disobey applicable law, or otherwise commits a violation of a material provision of this Contract, then the Owner, in addition to any other rights it may have against the Contractor or others, may terminate the performance of the Contractor and assume possession of the Project site and of all materials and equipment at the site and may complete the work. In such case, the Contractor shall not be paid further until the work is complete. After final completion has been achieved, if any portion of the Contract Price, as it may be modified hereunder, remains after the cost to the Owner of completing the work, including all costs and expenses of every nature incurred, has been deducted by the Owner, such remainder shall belong to the Contractor. Otherwise, the Contractor shall pay and make whole the Owner for such cost. This obligation for payment shall survive the termination of the Contract. In the event the employment of the Contractor is terminated by the Owner for cause pursuant to this Subparagraph 19(B) and it is subsequently determined by a Court of competent jurisdiction that such termination was without cause, such termination shall thereupon be deemed a Termination for Convenience under Subparagraph 19(A) and the provisions of Subparagraph 19(A) shall apply.

20. INSURANCE

The Contractor shall have and maintain insurance in accordance with the requirements of Exhibit "A" attached hereto and incorporated herein by reference.

21. SURETY BONDS

The Contractor shall furnish separate performance, payment, and maintenance bonds to the Owner. Each bond shall set forth a penal sum in an amount not less than the Contract Price. Each bond furnished by the Contractor shall incorporate by reference the terms of this Contract as fully as though they were set forth verbatim in such bonds and shall specifically reference paragraph 16(d) of this agreement. In the event the Contract Price is adjusted by Change Order executed by the Contractor, the penal sum of both the performance bond, payment bond, and maintenance bond shall be deemed increased by like amount. The performance, payment and maintenance bonds furnished by the Contractor shall be in form provided by the Owner and shall be executed by a surety, or sureties, reasonably acceptable to the Owner.

22. PROJECT RECORDS

All documents relating in any manner whatsoever to the Project, or any designated portion thereof, which are in the possession of the Contractor, or any subcontractor of the Contractor, shall be made available to the Owner for inspection and copying upon written request by the Owner. Furthermore, said documents shall be made available, upon request by the Owner, to any state, federal or other regulatory authority and any such authority may review, inspect and copy such records. Said records include, but are not limited to, all drawings, plans, specifications, submittals, correspondence, minutes, memoranda, tape recordings, videos, or other writings or things which document the Project, its design, and its construction. Said records expressly include those documents reflecting the cost of construction to the Contractor. The Contractor shall maintain and protect these documents for no less than four (4) years after final completion of the Project, or for any longer period of time as may be required by law or good construction practice.

23. APPLICABLE LAW

The law applicable to this Contract is hereby agreed to be the law of the State of Texas and venue shall be Collin County, Texas.

24. EXPENSES FOR ENFORCEMENT

In the event either Party hereto is required to employ an attorney to enforce the provisions of this Agreement or is required to commence legal proceedings to enforce the provisions hereof, the prevailing Party shall be entitled to recover from the other, reasonable attorney's fees and court costs incurred in connection with such enforcement, including collection.

25. SUCCESSORS AND ASSIGNS

Each party binds itself, its successors, assigns, executors, administrators or other representatives to the other party hereto and to successors, assigns, executors, administrators or other representatives of such other party in connection with all terms and conditions of this Contract. The Contractor shall not assign this Contract without prior written consent of the Owner.

26. NOTICES

All notices required or permitted hereunder shall be in writing and shall be deemed to have been duly delivered hereunder if mailed by first class certified mail, postage prepaid, to the respective parties at the respective addresses:

Owner:
Bill Burke
Construction Projects Director
4600 Community Ave.
McKinney, TX 75071

Contractor:

Any party may at any time change its address for such notices by delivering or mailing to the other parties hereto, in the manner provided above, a notice of such change.

OWNER
Collin County

CONTRACTOR

(TYPED NAME)

(TYPED NAME)

By: _____
(SIGNATURE)

By: _____
(SIGNATURE)

Michalyn Rains, CPPO, CPPB
Purchasing Agent
2300 Bloomdale Rd., Ste. 3160
McKinney, TX 75071

(PRINTED NAME, TITLE & ADDRESS)

(PRINTED NAME, TITLE & ADDRESS)

(DATE OF EXECUTION)

(DATE OF EXECUTION)

EXHIBIT "A"

Contractor's and Subcontractor's Insurance:

Before commencing work, the vendor shall be required, at its own expense, to furnish the Collin County Purchasing Agent with certified copies of all insurance certificate(s) indicating the coverage to remain in force throughout the term of this contract.

1. Commercial General Liability insurance including but not limited to the coverage indicated below. Coverage shall not exclude or limit Products/Completed Operations, Contractual Liability, or Cross Liability.
 - Each Occurrence: \$1,000,000
 - Personal & Adv. Injury: \$1,000,000
 - Products/Completed Operation: \$2,000,000
 - General Aggregate: \$2,000,000
2. Workers Compensation insurance as required by the laws of Texas, and Employers' Liability.
 - Liability, Each Accident: \$500,000
 - Disease-Each Employee: \$500,000
 - Disease – Policy Limit: \$500,000
3. Commercial Automobile Liability insurance including owned, non-owned, and hired vehicles used in connection with the contract.
 - Combined Single Limit – Each Accident: \$1,000,000
4. Umbrella/Excess Liability insurance.
 - Each Occurrence/Aggregate: \$1,000,000

With reference to the foregoing insurance requirement, the vendor shall endorse applicable insurance policies as follows:

1. A waiver of subrogation in favor of Collin County, its officials, employees, volunteers and officers shall be provided for General Liability, Commercial Automobile Liability and Workers' Compensation.
2. The vendor's insurance coverage shall name Collin County as additional insured under the General Liability policy.
3. All insurance policies shall be endorsed to require the insurer to immediately notify Collin County of any decrease in the insurance coverage limits.
4. All insurance policies shall be endorsed to the effect that Collin County will receive at least thirty (30) days' notice prior to cancellation, non-renewal or termination of the policy.
5. All copies of Certificates of Insurance shall reference the project/contract number.

All insurance shall be purchased from an insurance company that meets the following requirements:

1. A financial rating of A+VII or better as assigned by the BEST Rating Company or equivalent.

Certificates of Insurance shall be prepared and executed by the insurance company or its authorized agent, and shall contain provisions representing and warranting the following:

1. Sets forth all endorsements and insurance coverages according to requirements and instructions contained herein.
2. Sets forth the notice of cancellation or termination to Collin County.

INFORMATION REGARDING CONFLICT OF INTEREST QUESTIONNAIRE

During the 79th Legislative Session, House Bill 914 was signed into law effective September 1, 2015, which added Chapter 176 to the Texas Local Government Code. Recent changes have been made to Chapter 176 pursuant to HB23, which passed the 84th Legislative Session. Chapter 176 mandates the public disclosure of certain information concerning persons doing business or seeking to do business with Collin County, including family, business, and financial relationships such persons may have with Collin County officers or employees involved in the planning, recommending, selecting and contracting of a vendor for this procurement.

For a copy of Form CIQ and CIS:

http://www.ethics.state.tx.us/filinginfo/conflict_forms.htm

The vendor acknowledges by doing business or seeking to do business with Collin County that he/she has been notified of the requirements under Chapter 176 of the Texas Local Government Code and that he/she is solely responsible for complying with the terms and conditions therein. Furthermore, any individual or business entity seeking to do business with Collin County who does not comply with this practice may risk award consideration of any County contract.

For a listing of current Collin County Officers:

<http://www.collincountytexas.gov/government/Pages/officials.aspx>

The following County employees will be involved in the planning, recommending, selecting, and contracting for the attached procurement:

Department/Evaluation Team:

Bill Burke – Director of Building Projects

Brad Harris – Building Projects Coordinator

Purchasing:

Michalyn Rains – Purchasing Agent

Sara Hoglund, CPPB – Asst. Purchasing Agent

J. D. Griffin – Buyer II

Commissioners' Court:

Keith Self – County Judge

Susan Fletcher – Commissioner Precinct No. 1

Cheryl Williams – Commissioner Precinct No. 2

Chris Hill – Commissioner Precinct No. 3

Duncan Webb – Commissioner Precinct No. 4

CONFLICT OF INTEREST QUESTIONNAIRE

For vendor doing business with local governmental entity

FORM CIQ

This questionnaire reflects changes made to the law by H.B. 23, 84th Leg., Regular Session.

This questionnaire is being filed in accordance with Chapter 176, Local Government Code, by a vendor who has a business relationship as defined by Section 176.001(1-a) with a local governmental entity and the vendor meets requirements under Section 176.006(a).

By law this questionnaire must be filed with the records administrator of the local governmental entity not later than the 7th business day after the date the vendor becomes aware of facts that require the statement to be filed. See Section 176.006(a-1), Local Government Code.

A vendor commits an offense if the vendor knowingly violates Section 176.006, Local Government Code. An offense under this section is a misdemeanor.

OFFICE USE ONLY

Date Received

1 Name of vendor who has a business relationship with local governmental entity.

2 Check this box if you are filing an update to a previously filed questionnaire. (The law requires that you file an updated completed questionnaire with the appropriate filing authority not later than the 7th business day after the date on which you became aware that the originally filed questionnaire was incomplete or inaccurate.)

3 Name of local government officer about whom the information is being disclosed.

Name of Officer

4 Describe each employment or other business relationship with the local government officer, or a family member of the officer, as described by Section 176.003(a)(2)(A). Also describe any family relationship with the local government officer. Complete subparts A and B for each employment or business relationship described. Attach additional pages to this Form CIQ as necessary.

A. Is the local government officer or a family member of the officer receiving or likely to receive taxable income, other than investment income, from the vendor?

Yes No

B. Is the vendor receiving or likely to receive taxable income, other than investment income, from or at the direction of the local government officer or a family member of the officer AND the taxable income is not received from the local governmental entity?

Yes No

5 Describe each employment or business relationship that the vendor named in Section 1 maintains with a corporation or other business entity with respect to which the local government officer serves as an officer or director, or holds an ownership interest of one percent or more.

6 Check this box if the vendor has given the local government officer or a family member of the officer one or more gifts as described in Section 176.003(a)(2)(B), excluding gifts described in Section 176.003(a-1).

7

Signature of vendor doing business with the governmental entity

Date

CONFLICT OF INTEREST QUESTIONNAIRE

For vendor doing business with local governmental entity

A complete copy of Chapter 176 of the Local Government Code may be found at <http://www.statutes.legis.state.tx.us/Docs/LG/htm/LG.176.htm>. For easy reference, below are some of the sections cited on this form.

Local Government Code § 176.001(1-a): "Business relationship" means a connection between two or more parties based on commercial activity of one of the parties. The term does not include a connection based on:

- (A) a transaction that is subject to rate or fee regulation by a federal, state, or local governmental entity or an agency of a federal, state, or local governmental entity;
- (B) a transaction conducted at a price and subject to terms available to the public; or
- (C) a purchase or lease of goods or services from a person that is chartered by a state or federal agency and that is subject to regular examination by, and reporting to, that agency.

Local Government Code § 176.003(a)(2)(A) and (B):

(a) A local government officer shall file a conflicts disclosure statement with respect to a vendor if:

(2) the vendor:

(A) has an employment or other business relationship with the local government officer or a family member of the officer that results in the officer or family member receiving taxable income, other than investment income, that exceeds \$2,500 during the 12-month period preceding the date that the officer becomes aware that

- (i) a contract between the local governmental entity and vendor has been executed;
- or
- (ii) the local governmental entity is considering entering into a contract with the vendor;

(B) has given to the local government officer or a family member of the officer one or more gifts that have an aggregate value of more than \$100 in the 12-month period preceding the date the officer becomes aware that:

- (i) a contract between the local governmental entity and vendor has been executed; or
- (ii) the local governmental entity is considering entering into a contract with the vendor.

Local Government Code § 176.006(a) and (a-1)

(a) A vendor shall file a completed conflict of interest questionnaire if the vendor has a business relationship with a local governmental entity and:

- (1) has an employment or other business relationship with a local government officer of that local governmental entity, or a family member of the officer, described by Section 176.003(a)(2)(A);
- (2) has given a local government officer of that local governmental entity, or a family member of the officer, one or more gifts with the aggregate value specified by Section 176.003(a)(2)(B), excluding any gift described by Section 176.003(a-1); or
- (3) has a family relationship with a local government officer of that local governmental entity.

(a-1) The completed conflict of interest questionnaire must be filed with the appropriate records administrator not later than the seventh business day after the later of:

(1) the date that the vendor:

- (A) begins discussions or negotiations to enter into a contract with the local governmental entity; or
- (B) submits to the local governmental entity an application, response to a request for proposals or bids, correspondence, or another writing related to a potential contract with the local governmental entity; or

(2) the date the vendor becomes aware:

- (A) of an employment or other business relationship with a local government officer, or a family member of the officer, described by Subsection (a);
- (B) that the vendor has given one or more gifts described by Subsection (a); or
- (C) of a family relationship with a local government officer.

Request for Taxpayer Identification Number and Certification

**Give Form to the
 requester. Do not
 send to the IRS.**

Print or type See Specific Instructions on page 2.	1 Name (as shown on your income tax return). Name is required on this line; do not leave this line blank.	
	2 Business name/disregarded entity name, if different from above	
	3 Check appropriate box for federal tax classification; check only one of the following seven boxes: <input type="checkbox"/> Individual/sole proprietor or single-member LLC <input type="checkbox"/> C Corporation <input type="checkbox"/> S Corporation <input type="checkbox"/> Partnership <input type="checkbox"/> Trust/estate <input type="checkbox"/> Limited liability company. Enter the tax classification (C=C corporation, S=S corporation, P=partnership) ▶ _____ Note. For a single-member LLC that is disregarded, do not check LLC; check the appropriate box in the line above for the tax classification of the single-member owner. <input type="checkbox"/> Other (see instructions) ▶ _____	
	4 Exemptions (codes apply only to certain entities, not individuals; see instructions on page 3): Exempt payee code (if any) _____ Exemption from FATCA reporting code (if any) _____ <small>(Applies to accounts maintained outside the U.S.)</small>	
	5 Address (number, street, and apt. or suite no.)	Requester's name and address (optional)
	6 City, state, and ZIP code	
	7 List account number(s) here (optional)	

Part I Taxpayer Identification Number (TIN)

Enter your TIN in the appropriate box. The TIN provided must match the name given on line 1 to avoid backup withholding. For individuals, this is generally your social security number (SSN). However, for a resident alien, sole proprietor, or disregarded entity, see the Part I instructions on page 3. For other entities, it is your employer identification number (EIN). If you do not have a number, see *How to get a TIN* on page 3.

Note. If the account is in more than one name, see the instructions for line 1 and the chart on page 4 for guidelines on whose number to enter.

Social security number																				
<table style="width: 100%; border-collapse: collapse;"> <tr> <td style="border: 1px solid black; width: 20px; height: 20px;"></td> <td style="border: 1px solid black; width: 20px; height: 20px;"></td> <td style="border: 1px solid black; width: 20px; height: 20px;"></td> <td style="border: 1px solid black; width: 20px; height: 20px;"></td> <td style="border: 1px solid black; width: 20px; height: 20px;"></td> <td style="border: 1px solid black; width: 20px; height: 20px;"></td> <td style="border: 1px solid black; width: 20px; height: 20px;"></td> <td style="border: 1px solid black; width: 20px; height: 20px;"></td> <td style="border: 1px solid black; width: 20px; height: 20px;"></td> <td style="border: 1px solid black; width: 20px; height: 20px;"></td> <td style="border: 1px solid black; width: 20px; height: 20px;"></td> <td style="border: 1px solid black; width: 20px; height: 20px;"></td> <td style="border: 1px solid black; width: 20px; height: 20px;"></td> <td style="border: 1px solid black; width: 20px; height: 20px;"></td> <td style="border: 1px solid black; width: 20px; height: 20px;"></td> <td style="border: 1px solid black; width: 20px; height: 20px;"></td> <td style="border: 1px solid black; width: 20px; height: 20px;"></td> <td style="border: 1px solid black; width: 20px; height: 20px;"></td> <td style="border: 1px solid black; width: 20px; height: 20px;"></td> <td style="border: 1px solid black; width: 20px; height: 20px;"></td> </tr> </table>																				
or																				
Employer identification number																				
<table style="width: 100%; border-collapse: collapse;"> <tr> <td style="border: 1px solid black; width: 20px; height: 20px;"></td> <td style="border: 1px solid black; width: 20px; height: 20px;"></td> <td style="border: 1px solid black; width: 20px; height: 20px;"></td> <td style="border: 1px solid black; width: 20px; height: 20px;"></td> <td style="border: 1px solid black; width: 20px; height: 20px;"></td> <td style="border: 1px solid black; width: 20px; height: 20px;"></td> <td style="border: 1px solid black; width: 20px; height: 20px;"></td> <td style="border: 1px solid black; width: 20px; height: 20px;"></td> <td style="border: 1px solid black; width: 20px; height: 20px;"></td> <td style="border: 1px solid black; width: 20px; height: 20px;"></td> <td style="border: 1px solid black; width: 20px; height: 20px;"></td> <td style="border: 1px solid black; width: 20px; height: 20px;"></td> <td style="border: 1px solid black; width: 20px; height: 20px;"></td> <td style="border: 1px solid black; width: 20px; height: 20px;"></td> <td style="border: 1px solid black; width: 20px; height: 20px;"></td> <td style="border: 1px solid black; width: 20px; height: 20px;"></td> <td style="border: 1px solid black; width: 20px; height: 20px;"></td> <td style="border: 1px solid black; width: 20px; height: 20px;"></td> <td style="border: 1px solid black; width: 20px; height: 20px;"></td> <td style="border: 1px solid black; width: 20px; height: 20px;"></td> </tr> </table>																				

Part II Certification

Under penalties of perjury, I certify that:

- The number shown on this form is my correct taxpayer identification number (or I am waiting for a number to be issued to me); and
- I am not subject to backup withholding because: (a) I am exempt from backup withholding, or (b) I have not been notified by the Internal Revenue Service (IRS) that I am subject to backup withholding as a result of a failure to report all interest or dividends, or (c) the IRS has notified me that I am no longer subject to backup withholding; and
- I am a U.S. citizen or other U.S. person (defined below); and
- The FATCA code(s) entered on this form (if any) indicating that I am exempt from FATCA reporting is correct.

Certification instructions. You must cross out item 2 above if you have been notified by the IRS that you are currently subject to backup withholding because you have failed to report all interest and dividends on your tax return. For real estate transactions, item 2 does not apply. For mortgage interest paid, acquisition or abandonment of secured property, cancellation of debt, contributions to an individual retirement arrangement (IRA), and generally, payments other than interest and dividends, you are not required to sign the certification, but you must provide your correct TIN. See the instructions on page 3.

Sign Here	Signature of U.S. person ▶	Date ▶
------------------	----------------------------	--------

General Instructions

Section references are to the Internal Revenue Code unless otherwise noted.
Future developments. Information about developments affecting Form W-9 (such as legislation enacted after we release it) is at www.irs.gov/fw9.

Purpose of Form

An individual or entity (Form W-9 requester) who is required to file an information return with the IRS must obtain your correct taxpayer identification number (TIN) which may be your social security number (SSN), individual taxpayer identification number (ITIN), adoption taxpayer identification number (ATIN), or employer identification number (EIN), to report on an information return the amount paid to you, or other amount reportable on an information return. Examples of information returns include, but are not limited to, the following:

- Form 1099-INT (interest earned or paid)
- Form 1099-DIV (dividends, including those from stocks or mutual funds)
- Form 1099-MISC (various types of income, prizes, awards, or gross proceeds)
- Form 1099-B (stock or mutual fund sales and certain other transactions by brokers)
- Form 1099-S (proceeds from real estate transactions)
- Form 1099-K (merchant card and third party network transactions)

- Form 1098 (home mortgage interest), 1098-E (student loan interest), 1098-T (tuition)
- Form 1099-C (canceled debt)
- Form 1099-A (acquisition or abandonment of secured property)

Use Form W-9 only if you are a U.S. person (including a resident alien), to provide your correct TIN.

If you do not return Form W-9 to the requester with a TIN, you might be subject to backup withholding. See What is backup withholding? on page 2.

By signing the filled-out form, you:

1. Certify that the TIN you are giving is correct (or you are waiting for a number to be issued),
2. Certify that you are not subject to backup withholding, or
3. Claim exemption from backup withholding if you are a U.S. exempt payee. If applicable, you are also certifying that as a U.S. person, your allocable share of any partnership income from a U.S. trade or business is not subject to the withholding tax on foreign partners' share of effectively connected income, and
4. Certify that FATCA code(s) entered on this form (if any) indicating that you are exempt from the FATCA reporting, is correct. See *What is FATCA reporting?* on page 2 for further information.