

Solicitation 07334-12

Construction, Towers and Zip Lines



Collin County

Bid 07334-12 Construction, Towers and Zip Lines

Bid Number 07334-12
 Bid Title Construction, Towers and Zip Lines

Bid Start Date In Held
 Bid End Date Aug 30, 2012 2:00:00 PM CDT
 Question & Answer End Date Aug 29, 2012 12:00:00 PM CDT

Bid Contact Matt Dobecka CPPB
 Contract Administrator
 Collin County Purchasing
 972-548-4103
 mdobecka@co.collin.tx.us

Contract Duration One Time Purchase
 Contract Renewal Not Applicable
 Prices Good for 90 days
 Pre-Bid Conference Aug 24, 2012 1:00:00 PM CDT
 Attendance is optional
 Location: Collin County Adventure Camp
 1180 W. Houston St.
 Anna, TX 75409

Standard Disclaimer ***Note to Bidders/Offerors~The following standard disclaimer applies to Invitation to Bid (IFB), Competitive Sealed Proposal (CSP), and Request for Proposal (RFP) ONLY, not applicable to Request for Qualifications (RFQ) or Request for Information (RFI).***
 Mailing Address:
 Collin County Purchasing
 2300 Bloomdale Rd., Ste 3160
 McKinney, TX 75071
 Prices bid/proposed shall only be considered if they are provided in the appropriate space(s) on the Collin County bid form(s). For consideration, any additions or deductions to the bid/proposal prices offered must be shown under the exceptions section of the bid/proposal in the case of electronic submittal, ONLY in the case of a hard copy submittal will an additional attachment be allowed. Extraneous numbers, prices, comments, etc. or bidder/offeror generated documents appearing elsewhere on the bid or as an additional attachment shall be deemed to have no effect on the prices offered in the designated locations.
 All delivery and freight charges (F.O.B. inside delivery at Collin County designated locations) are to be included as part of the bid/quote/proposal price. All components required to render the item complete, installed and operational shall be included in the total bid/quote/proposal price. Collin County will pay no additional freight/delivery/installation/setup fees.

Bid Comments By order of the Commissioners' Court of Collin County, Texas sealed bids will be received for the construction of two towers and twin zip lines at the Collin County Adventure Camp.

Item Response Form

Item 07334-12--01-01 - Construction of Towers and Twin Zip Lines
 Quantity 1 lump sum
 Unit Price
 Delivery Location Collin County
Collin County Adventure Camp
 1180 Houston St
 Anna TX 75409
 Qty 1

Description
 Construction of Towers and Twin Zip Lines



COLLIN COUNTY, TEXAS TERMS AND CONDITIONS

1.0 GENERAL INSTRUCTIONS

1.0.1 Definitions

1.0.1.1 Bidder/Quoter/Offeror: refers to submitter.

1.0.1.2 Vendor/Contractor/Provider: refers to a Successful Bidder/Quoter/Contractor/Service Provider.

1.0.1.3 Submittal: refers to those documents required to be submitted to Collin County, by a Bidder/Quoter/Offeror.

1.0.1.4 IFB: refers to Invitation For Bid.

1.0.1.5 RFQ: refers to Request For Qualifications

1.0.1.6 RFP: refers to Request For Proposal.

1.0.1.7 RFI: refers to Request For Information.

1.0.1.8 CSP: refers to Competitive Sealed Proposal

1.0.1.9 Quotation: refers to Request for Quotation

1.1 If Bidder/Quoter/Offeror do not wish to submit an offer at this time, please submit a No Bid Form.

1.2 Awards shall be made not more than ninety (90) days after the time set for opening of submittals.

1.3 Collin County is always conscious and extremely appreciative of your time and effort in preparing your submittal.

1.4 Collin County exclusively uses BidSync for the notification and dissemination of all solicitations. The receipt of solicitations through any other company may result in your receipt of incomplete specifications and/or addendums which could ultimately render your bid non-compliant. Collin County accepts no responsibility for the receipt and/or notification of solicitations through any other company.

1.5 A bid/quote/submittal may not be withdrawn or canceled by the bidder/quoter/offeror prior to the ninety-first (91st) day following public opening of submittals and only prior to award.

1.6 It is understood that Collin County, Texas reserves the right to accept or reject any and/or all Bids/Quotes/Proposals/Submittals for any or all products and/or services covered in an Invitation For Bid (IFB), Request For Qualifications (RFQ), Request For Proposal (RFP), Request For Information (RFI), Competitive Sealed Proposal (CSP), and Quotation, and to waive informalities or defects in submittals or to accept such submittals as it shall deem to be in the best interest of Collin County.

1.7 All IFB's, RFP's, CSP's, RFQ's, and RFI's submitted in hard copy paper form shall be submitted in a sealed envelope, plainly marked on the outside with the IFB/RFP/RFQ/RFI/CSP/Quotation number and name. A hard copy paper form submittal shall be manually signed in ink by a person having the authority to bind the firm in a contract. Submittals shall be mailed or hand delivered to the Collin County Purchasing Department.

1.8 No oral, telegraphic or telephonic submittals will be accepted. IFB's, RFP's, RFQ's, CSP's, and RFI's, may be submitted in electronic format via **BidSync**.

1.9 All Invitation For Bids (IFB), Request For Proposals (RFP), Request For Qualifications (RFQ), Competitive Sealed Proposals (CSP), and Request For Information (RFI), submitted electronically via **BidSync** shall remain locked until official date and time of opening as stated in the Special Terms and Conditions of the IFB, RFP, RFQ, CSP, and/or RFI.

1.10 Time/date stamp clock in Collin County Purchasing Department shall be the official time of receipt for all Invitation For Bids (IFB), Request For Proposals (RFP), Request For Qualifications (RFQ), Competitive Sealed Proposals (CSP), Request For Information (RFI), submitted in hard copy paper form. IFB's, RFP's, RFQ's, CSP's, RFI's, received in County Purchasing Department after submission deadline shall be considered void and unacceptable. Absolutely no late submittals will be considered. Collin County accepts no responsibility for technical difficulties related to electronic submittals.

1.11 For hard copy paper form submittals, any alterations made prior to opening date and time must be initialed by the signer of the IFB/RFQ/RFP/CSP/RFI/, guaranteeing authenticity. Submittals cannot be altered or amended after submission deadline.

1.12 Collin County is by statute exempt from the State Sales Tax and Federal Excise Tax; therefore, the prices submitted shall not include taxes.

1.13 Any interpretations, corrections and/or changes to an Invitation For Bid/Request For Qualifications/Request For Proposal/Request for Information/Competitive Sealed Proposal, and related Specifications or extensions to the opening/receipt date will be made by addenda to the respective document by the Collin County Purchasing Department. Questions and/or clarification requests must be submitted no later than seven (7) days prior to the opening/receipt date. Those received at a later date may not be addressed prior to the public opening. Sole authority to authorize addenda shall be vested in Collin County Purchasing Agent as entrusted by the Collin County Commissioners' Court. Addenda may be transmitted electronically via **BidSync**, by facsimile, E-mail transmission or mailed via the US Postal Service.

1.13.1 Addenda will be transmitted to all that are known to have received a copy of the IFB/RFQ/RFP/RFI/CSP and related Specifications. However, it shall be the sole responsibility of the Bidder/Quoter/Offeror to verify issuance/non-issuance of addenda and to check all avenues of document availability (i.e. **BidSync** at www.bidsync.com, telephoning Purchasing Department directly, etc.) prior to opening/receipt date and time to insure Bidder/Quoter/Offeror's receipt of any addenda issued. Bidder/Quoter/Offeror shall acknowledge receipt of all addenda.

1.14 All materials and services shall be subject to Collin County approval.

1.15 Collin County reserves the right to make award in whole or in part as it deems to be in the best interest of the County.

1.16 The Bidder/Quoter/Offeror shall comply with Commissioners' Court Order No. 96-680-10-28, Establishment of Guidelines & Restrictions Regarding the Acceptance of Gifts by County Officials & County

Employees.

1.17 Any reference to model/make and/or manufacturer used in specifications is for descriptive purposes only. Products/materials of like quality will be considered.

1.18 Bidders/Quoters/Offerors taking exception to the specifications shall do so at their own risk. By offering substitutions, Bidder/Quoter/Offeror shall state these exceptions in the section provided in the IFB/RFQ/RFP/CSP/Quotation or by attachment. Exception/substitution, if accepted, must meet or exceed specifications stated therein. Collin County reserves the right to accept or reject any and/or all of the exception(s)/substitution(s) deemed to be in the best interest of the County.

1.19 Minimum Standards for Responsible Prospective Bidders/Quoters/Offerors: A prospective Bidder/Quoter/Offeror must meet the following minimum requirements:

1.19.1 have adequate financial resources, or the ability to obtain such resources as required;

1.19.2 be able to comply with the required or proposed delivery/completion schedule;

1.19.3 have a satisfactory record of performance;

1.19.4 have a satisfactory record of integrity and ethics;

1.19.5 be otherwise qualified and eligible to receive an award.

Collin County may request documentation and other information sufficient to determine Bidder's/Quoter's/Offeror's ability to meet these minimum standards listed above.

1.20 Vendor shall bear any/all costs associated with its preparation of an RFI/IFB/RFQ/RFP/CSP/Quotation submittal.

1.21 Public Information Act: Collin County is governed by the Texas Public Information Act, Chapter 552 of the Texas Government Code. All information submitted by prospective bidders during the bidding process is subject to release under the Act.

1.22 The Bidder/Quoter/Offeror shall comply with Commissioners' Court Order No. 2004-167-03-11, County Logo Policy.

1.23 Interlocal Agreement: Successful bidder agrees to extend prices and terms to all entities that has entered into or will enter into joint purchasing interlocal cooperation agreements with Collin County.

1.24 Bid Openings: All bids submitted will be read at the county's regularly scheduled bid opening for the designated project. However, the reading of a bid at bid opening should be not construed as a comment on the responsiveness of such bid or as any indication that the county accepts such bid as responsive.

The county will make a determination as to the responsiveness of bids submitted based upon compliance with all applicable laws, Collin County Purchasing Guidelines, and project documents, including but not limited to the project specifications and contract documents. The county will notify the successful bidder upon award of the contract and, according to state law; all bids received will be available for inspection at that time.

2.0 TERMS OF CONTRACT

2.1 A bid/quote/proposal, when properly accepted by Collin County, shall constitute a contract equally binding between the Vendor/Contractor/Provider and Collin County. No different or additional terms will become part of this contract with the exception of an Amendment and/or a Change Order.

2.2 No oral statement of any person shall modify or otherwise change, or affect the terms, conditions or specifications stated in the resulting contract. All Amendments and/or Change Orders to the contract will be made in writing by Collin County Purchasing Agent.

2.3 No public official shall have interest in the contract, in accordance with Vernon's Texas Codes Annotated, Local Government Code Title 5, Subtitle C, Chapter 171.

2.4 The Vendor/Contractor/Provider shall comply with Commissioners' Court Order No. 96-680-10-28, Establishment of Guidelines & Restrictions Regarding the Acceptance of Gifts by County Officials & County Employees.

2.5 Design, strength, quality of materials and workmanship must conform to the highest standards of manufacturing and engineering practice.

2.6 Bids/Quotes/Proposals must comply with all federal, state, county and local laws concerning the type(s) of product(s)/service(s)/equipment/project(s) contracted for, and the fulfillment of all ADA (Americans with Disabilities Act) requirements.

2.7 All products must be new and unused, unless otherwise specified, in first-class condition and of current manufacture. Obsolete products, including products or any parts not compatible with existing hardware/software configurations will not be accepted.

2.8 Vendor/Contractor/Provider shall provide any and all notices as may be required under the Drug-Free Work Place Act of 1988, 28 CFR Part 67, Subpart F, to its employees and all sub-contractors to insure that Collin County maintains a drug-free work place.

2.9 Vendor/Contractor/Provider shall defend, indemnify and save harmless Collin County and all its officers, agents and employees and all entities, their officers, agents and employees who are participating in this contract from all suits, claims, actions, damages (including personal injury and or property damages), or demands of any character, name and description, (including attorneys' fees, expenses and other defense costs of any nature) brought for or on account of any injuries or damages received or sustained by any person, persons, or property on account of Vendor/Contractor/Provider's breach of the contract arising from an award, and/or any negligent act, error, omission or fault of the Vendor/Contractor/Provider, or of any agent, employee, subcontractor or supplier of Vendor/Contractor/Provider in the execution of, or performance under, any contract which may result from an award. Vendor/Contractor/Provider shall pay in full any judgment with costs, including attorneys' fees and expenses which are rendered against Collin County and/or participating entities arising out of such breach, act, error, omission and/or fault.

2.10 If a contract, resulting from a Collin County IFB, RFP, RFQ, CSP, Quotation is for the execution of a public work, the following shall apply:

2.10.1 In accordance with V.T.C.A. 2253.021, a governmental agency that makes a public work contract with a prime contractor shall require the contractor, before beginning work, to execute to the governmental entity a Payment Bond if the contract is in excess of \$25,000.00. Such bond shall be in the amount of the contract payable to the governmental entity and must be executed by a corporate surety in accordance with Section 1, Chapter 87, Acts of the 56th Legislature, Regular Session, 1959 (Article 7.19-1 Vernon's Texas Insurance Code).

2.10.2 In accordance with V.T.C.A. 2253.021, a governmental agency that makes a public work contract with a prime contractor shall require the contractor, before beginning work, to execute to the governmental entity a Performance Bond if the contract is in excess of \$100,000.00. Such bond shall be in the amount of the contract payable to the governmental entity and must be executed by a corporate surety in accordance with Section 1, Chapter 87, Acts of the 56th Legislature, Regular Session, 1959 (Article 7.19-1 Vernon's Texas Insurance Code).

2.11 Purchase Order(s) shall be generated by Collin County to the vendor. Collin County will not be responsible for any orders placed/delivered without a valid purchase order number.

2.12 The contract shall remain in effect until any of the following occurs: delivery of product(s) and/or completion and acceptance by Collin County of product(s) and/or service(s), contract expires or is terminated by either party with thirty (30) days written notice prior to cancellation and notice must state therein the reasons for such cancellation. Collin County reserves the right to terminate the contract immediately in the event the Vendor/Contractor/Provider fails to meet delivery or completion schedules, or otherwise perform in accordance with the specifications. Breach of contract or default authorizes the County to purchase elsewhere and charge the full increase in cost and handling to the defaulting Vendor/Contractor/Provider.

2.13 Collin County Purchasing Department shall serve as Contract Administrator or shall supervise agents designated by Collin County.

2.14 All delivery and freight charges (FOB Inside delivery at Collin County designated locations) are to be included as part of the bid/quote/proposal price. All components required to render the item complete, installed and operational shall be included in the total bid/quote/proposal price. Collin County will pay no additional freight/delivery/installation/setup fees.

2.15 Vendor/Contractor/Provider shall notify the Purchasing Department immediately if delivery/completion schedule cannot be met. If delay is foreseen, the Vendor/Contractor/Provider shall give written notice to the Purchasing Agent. The County has the right to extend delivery/completion time if reason appears valid.

2.16 The title and risk of loss of the product(s) shall not pass to Collin County until Collin County actually receives and takes possession of the product(s) at the point or points of delivery. Collin County shall generate a purchase order(s) to the Vendor/Contractor/Provider and the purchase order number must appear on all itemized invoices.

2.17 Invoices shall be mailed directly to the Collin County Auditor's Office, 2300 Bloomdale Road, Suite 3100, McKinney, Texas 75071. All invoices shall show:

2.17.1 Collin County Purchase Order Number;

2.17.2 Vendor's/Contractor's/Provider's Name, Address and Tax Identification Number;

2.17.3 Detailed breakdown of all charges for the product(s) and/or service(s) including applicable time frames.

2.18 Payment will be made in accordance with V.T.C.A., Government Code, Title 10, Subtitle F, Chapter 2251.

2.19 All warranties shall be stated as required in the Uniform Commercial Code.

2.20 The Vendor/Contractor/Provider and Collin County agree that both parties have all rights, duties, and remedies available as stated in the Uniform Commercial Code.

2.21 The Vendor/Contractor/Provider agree to protect Collin County from any claims involving infringements of patents and/or copyrights.

2.22 The contract will be governed by the laws of the State of Texas. Should any portion of the contract be in conflict with the laws of the State of Texas, the State laws shall invalidate only that portion. The remaining portion of the contract shall remain in effect. The contract is performable in Collin County, Texas.

2.23 The Vendor/Contractor/Provider shall not sell, assign, transfer or convey the contract, in whole or in part, without the prior written approval from Collin County.

2.24 The apparent silence of any part of the specification as to any detail or to the apparent omission from it of a detailed description concerning any point, shall be regarded as meaning that only the best commercial practices are to prevail. All interpretations of the specification shall be made on the basis of this statement.

2.25 Vendor/Contractor/Provider shall not fraudulently advertise, publish or otherwise make reference to the existence of a contract between Collin County and Vendor/Contractor/Provider for purposes of solicitation. As exception, Vendor/Contractor/Provider may refer to Collin County as an evaluating reference for purposes of establishing a contract with other entities.

2.26 The Vendor/Contractor/Provider understands, acknowledges and agrees that if the Vendor/Contractor/Provider subcontracts with a third party for services and/or material, the primary Vendor/Contractor/Provider (awardee) accepts responsibility for full and prompt payment to the third party. Any dispute between the primary Vendor/Contractor/Provider and the third party, including any payment dispute, will be promptly remedied by the primary vendor. Failure to promptly render a remedy or to make prompt payment to the third party (subcontractor) may result in the withholding of funds from the primary Vendor/Contractor/Provider by Collin County for any payments owed to the third party.

2.27 Vendor/Contractor/Provider shall provide Collin County with diagnostic access tools at no additional cost to Collin County, for all Electrical and Mechanical systems, components, etc., procured through this contract.

2.28 Criminal History Background Check: If required, ALL individuals may be subject to a criminal history background check performed by the Collin County's Sheriff's Office prior to access being granted to Collin County. Upon request, Vendor/Contractor/Provider shall provide list of individuals to Collin County Purchasing Department within five (5) working days.

2.29 Non-Disclosure Agreement: Where applicable, vendor shall be required to sign a non-disclosure agreement acknowledging that all information to be furnished is in all respects confidential in nature, other than information which is in the public domain through other means and that any disclosure or use of same by vendor, except as provided in the contract/agreement, may cause serious harm or damage to Collin County. Therefore, Vendor agrees that Vendor will not use the information furnished for any purpose other than that stated in contract/agreement, and agrees that Vendor will not either directly or indirectly by agent, employee, or representative disclose this information, either in whole or in part, to any third party, except on a need to know basis for the purpose of evaluating any possible transaction. This agreement shall be binding upon Collin County and Vendor, and upon the directors, officers, employees and agents of each.

2.30 Vendors/Contractors/Providers must be in compliance with the Immigration and Reform Act of 1986 and all employees specific to this solicitation must be legally eligible to work in the United States of America.

2.31 Certification of Eligibility: This provision applies if the anticipated Contract exceeds \$100,000.00 and as it relates to the expenditure of federal grant funds. By submitting a bid or proposal in response to this solicitation, the Bidder/Quoter/Offeror certifies that at the time of submission, he/she is not on the Federal Government's list of suspended, ineligible, or debarred contractors. In the event of placement on the list between the time of bid/proposal submission and time of award, the Bidder/Quoter/Offeror will notify the Collin County Purchasing Agent. Failure to do so may result in terminating this contract for default.

2.32 Notice to Vendors/Contractors/Providers delivering goods or performing services within the Collin County Detention Facility: The Collin County Detention Facility houses persons who have been charged with and/or convicted of serious criminal offenses. When entering the Detention Facility, you could: (1) hear obscene or graphic language; (2) view partially clothed male inmates; (3) be subjected to verbal abuse or taunting; (4) risk physical altercations or physical contact, which could be minimal or possibly serious; (5) be exposed to communicable or infectious diseases; (6) be temporarily detained or prevented from immediately leaving the Detention Facility in the case of an emergency or "lockdown"; and (7) subjected to a search of your person or property. While the Collin County Sheriff's Office takes every reasonable precaution to protect the safety of visitors to the Detention Facility, because of the inherently dangerous nature of a Detention Facility and the type of the persons incarcerated therein, please be advised of the possibility of such situations exist and you should carefully consider such risks when entering the Detention Facility. By entering the Collin County Detention

Facility, you acknowledge that you are aware of such potential risks and willingly and knowingly choose to enter the Collin County Detention Facility.

2.33 Delays and Extensions of Time when applicable:

2.33.1 If the Vendor/Contractor/Provider is delayed at any time in the commence or progress of the Work by an act or neglect of the Owner or Architect/Engineer, or of an employee of either, or of a separate contractor employed by the Owner, or by changes ordered in the Work, or by labor disputes, fire, unusual delay in deliveries, unavoidable casualties or other causes beyond the Vendor/Contractor/Provider's control, or by delay authorized by the Owner pending mediation and arbitration, or by other causes which the Owner or Architect/Engineer determines may justify delay, then the Contract Time shall be extended by Change Order for such reasonable time as the Owner/Architect may determine.

2.33.2 If adverse weather conditions are the basis for a Claim for additional time, such Claim shall be documented by data substantiating that weather conditions were abnormal for the period of time and could not have been reasonably anticipated, and that the weather conditions had an adverse effect on the scheduled construction.

NOTE: All other terms and conditions (i.e. Insurance Requirements, Bond Requirements, etc.) shall be stated in the individual IFB/RFQ/RFP/RFI/CSP/Quotation Solicitation documents as Special Terms, Conditions and Specifications.

3.0 INSURANCE REQUIREMENTS

3.1 Before commencing work, the vendor shall be required, at its own expense, to furnish the Collin County Purchasing Agent and the YMCA's Risk Manager with certified copies of all insurance certificate(s) indicating the coverage to remain in force throughout the term of this contract.

3.1.1 Commercial General Liability insurance at minimum combined single limits of (\$1,000,000 per-occurrence and \$2,000,000 general aggregate) for bodily injury and property damage, which coverage shall include products/completed operations, independent contractors, and contractual liability each at \$500,000 per occurrence. Coverage must be written on an occurrence form.

3.1.2 Workers Compensation insurance at statutory limits, including employers liability coverage at minimum limits. In addition to these, the contractor must meet each stipulation below as required by the Texas Workers Compensation Commission; (Note: If you have questions concerning these requirements, you are instructed to contact the TWCC at (512)440-3789).

3.1.2.1 Definitions: Certificate of coverage ("certificate"); A copy of a certificate of authority of self-insure issued by the commission, or a coverage agreement (TWCC-81, TWCC-82, TWCC-83, OR TWCC-84), showing statutory workers compensation insurance coverage for the person's or entity's employees providing services on a project, for the duration of the project.

Duration of the project includes the time from the beginning of the work on the project until the contractor's/person's work on the project has been completed and accepted by the governmental entity.

Persons providing services on the project ("subcontractor" in 406.096) includes all persons or entities performing all or part of the services the contractor has undertaken to perform on the project, regardless of whether that person has employees. This includes, without limitation, independent contractors, subcontractors, leasing companies, motor carriers, owner-operators, employees of any such entity, or employees of any entity which furnishes persons to provide services on the project. "Services" include, without limitation, providing, hauling, or delivering equipment or materials, or providing labor, transportation, or other service related to a project. "Services" does not include activities unrelated to the project, such as food/beverage vendors, office supply deliveries, and delivery of portable toilets.

3.1.2.2 The contractor shall provide coverage, based on proper reporting of classification codes and payroll amounts and filing of any coverage agreements, which meets the statutory requirements of Texas Labor Code, Section 401.011(44) for all employees of the contractor providing services on the project, for the duration of the project.

3.1.2.3 The Contractor must provide a certificate of coverage to the governmental entity and the YMCA of Metropolitan Dallas prior to being awarded the contract.

3.1.2.4 If the coverage period shown on the contractor's current certificate of coverage ends during the duration of the project, the contractor must, prior to the end of the coverage period, file a new certificate of coverage with the governmental entity showing that coverage has been extended.

3.1.2.5 The contractor shall obtain from each person providing services on a project, and provide to the governmental entity:

3.1.2.5.1 A certificate of coverage, prior to that person beginning work on the project, so the governmental entity will have on file certificates of coverage showing coverage for all persons providing services on the project; and

3.1.2.5.2 no later than seven days after receipt by the contractor, a new certificate of coverage showing extension of coverage, if the coverage period shown on the current certificate of coverage ends during the duration of the project.

3.1.2.6 The contractor shall retain all required certificates of coverage for the duration of the project and for one year thereafter.

3.1.2.7 The contractor shall notify the governmental entity in writing by certified mail or personal delivery, within 10 days after the contractor knew or should have known, of any change that materially affects the provision of coverage of any person providing services on the project.

3.1.2.8 The contractor shall post on each project site a notice, in the text, form and manner prescribed by the Texas Workers Compensation Commission, informing all persons providing services on the project that they are required to be covered, and stating how a person may verify coverage and report lack of coverage.

3.1.2.9 The contractor shall contractually require each person with whom it contracts to provide services on a project, to:

3.1.2.9.1 provide coverage, based on proper reporting of classification codes and payroll amounts and filing of any coverage agreements, which meets the statutory requirements of Texas Labor Code, Section 401.011(44) for all of its employees providing services on the project, for the duration of the project;

3.1.2.9.2 provide to the contractor, prior to that person beginning work on the project, a certificate of coverage showing that coverage is being provided for all employees of the person providing services on the project, for the duration of the project;

3.1.2.9.3 provide the contractor, prior to the end of the coverage period, a new certificate of coverage showing extension of coverage, if the coverage period shown on the current certificate of coverage ends during the duration of the project;

3.1.2.9.4 obtain from each other person with whom it contracts, and provide to the contractor:

3.1.2.9.4.1 a certificate of coverage, prior to the other person beginning work on the project; and

3.1.2.9.4.2 a new certificate of coverage showing extension of coverage, prior to the end of the coverage period, if the coverage period shown on the current certificate of coverage ends during the duration of the project;

3.1.2.9.5 retain all required certificates of coverage on file for the duration of the project and for one year thereafter;

3.1.2.9.6 notify the governmental entity and the YMCA of Metropolitan Dallas in writing by certified mail or personal delivery, within 10 days after the person knew or should have known, of any change that materially affects the provision of coverage of any person providing services on the project; and

3.1.2.9.7 contractually require each person with whom it contracts, to perform as required by paragraphs 3.1.2.1 through 3.1.2.7, with the certificates of coverage to be provided to the person for whom they are providing services.

3.1.2.10 By signing this contract or providing or causing to be provided a certificate of coverage, the contractor is representing to the governmental entity and the YMCA of Metropolitan Dallas that all employees of the contractor who will provide services on the project will be covered by workers compensation coverage for the duration of the project, that the coverage will be based on proper reporting of classification codes and payroll amounts, and that all coverage agreements will be filed with the appropriate insurance carrier or, in the case of a self-insured, with the commission's Division of Self-Insurance Regulation. Providing false or misleading information may subject the contractor to administrative penalties, criminal penalties, civil penalties, or other civil actions.

3.1.2.11 The contractor's failure to comply with any of these provisions is a breach of contract by the contractor which entitles the governmental entity to declare the contract void if the contractor does not remedy the breach within ten days after receipt of notice of breach from the governmental entity.

3.1.3 Commercial Automobile Liability insurance shall be no less than \$500,000 combined single limits per accident for bodily injury and property damage, including owned, non-owned, and hired vehicle coverage.

3.1.4 Professional Liability Insurance at minimum limits of \$1,000,000. This policy must have a two (2) year extended period of coverage, (i.e. tail coverage). If you choose to have project coverage endorsed onto your base policy, this would be acceptable.

3.2 The required limits may be satisfied by any combination of primary, excess or umbrella liability insurances, provided the primary policy complies with the above

requirements and the excess umbrella is following form. The vendor may maintain reasonable and customary deductibles, subject to approval by Collin County.

3.3 With reference to the foregoing insurance requirement, the vendor shall endorse applicable insurance policies as follows:

3.3.1 A waiver of subrogation in favor of Collin County, the YMCA of Metropolitan Dallas, its officials, employees, volunteers and officers shall be contained in the workers compensation coverage.

3.3.2 The vendor's insurance coverage shall name Collin County and the YMCA of Metropolitan Dallas as additional insured under the General Liability policy.

3.3.3 All insurance policies shall be endorsed to require the insurer to immediately notify Collin County of any decrease in the insurance coverage limits.

3.3.4 All insurance policies shall be endorsed to the effect that Collin County and the YMCA of Metropolitan Dallas will receive at least thirty (30) days notice prior to cancellation, non-renewal or termination of the policy.

3.3.5 All copies of Certificates of Insurance shall reference the project/contract number.

3.4 All insurance shall be purchased from an insurance company that meets the following requirements:

3.4.1 A financial rating of B+VI or better as assigned by the BEST Rating Company or equivalent.

3.5 Certificates of Insurance shall be prepared and executed by the insurance company or its authorized agent, and shall contain provisions representing and warranting the following:

3.5.1 Sets forth all endorsements and insurance coverages according to requirements and instructions contained herein.

3.5.2 Sets forth the notice of cancellation or termination to Collin County.

*Completed forms should be mailed to:

Collin County Purchasing Agent
2300 Bloomdale Rd.
Ste 3160
McKinney, TX 75071

YMCA of Metropolitan Dallas
Attn: Stanley Smith
601 N. Akard Street
Dallas, Texas 75201

4.0 SPECIAL CONDITIONS AND SPECIFICATIONS

4.1 Authorization: By order of the Commissioners' Court of Collin County, Texas sealed bids will be received for the construction of two towers and twin zip lines at the Collin County Adventure Camp.

4.2 Purpose: The intended use/purpose for this Invitation for Bid is to describe the construction of two towers and twin zip lines at the Collin County Adventure Camp.

4.3 Pre-Bid Conference: A pre-bid conference will be held on **Friday, August 24, 2012 at 1:00 P.M.** The location of the pre-bid will be at **Collin County Adventure Camp, 1180 W. Houston St., Anna, TX 75409.**

4.4 Funding: Funds for payment have been provided through the Collin County budget approved by the Commissioners' Court for this fiscal year only. State of Texas statutes prohibit the County from any obligation of public funds beyond the fiscal year for which a budget has been approved. Therefore, anticipated orders or other obligations that may arise past the end of the current Collin County fiscal year shall be subject to budget approval.

4.5 Delivery/Completion/Response Time: Vendor shall place product(s) and/or complete services at the County's designated location within the calendar days specified on the Collin County purchase order.

4.6 Fabrication/Delivery/Setup/Installation Locations: Location for delivery and installation is Collin County Adventure Camp, 1180 W. Houston St., Anna, TX 75409. Delivery **shall** include assembly, set-up and installation.

4.7 Samples/Demos: When requested, color samples/demos shall be furnished to the County at no expense.

4.8 Descriptive Literature: Each bidder is requested to submit with this bid descriptive literature sufficient in detail to enable an intelligent comparison of the specification of the product(s) bid. Failure to provide literature with this Invitation for Bid may result in rejection of the bid or that part of the bid.

4.9 The Contractor shall post with Owner, not later than ten (10) consecutive calendar days of Collin County Commissioners' Court award of Contract, a Performance Bond in the amount of one hundred percent (100%) of the total contract price in such form as is satisfactory to Owner, in compliance with Chapter 2253 of the Texas Government Code and all other applicable Texas Law, and on the form specified in the Contract Documents. This bond shall be executed by a corporate surety company duly authorized and admitted to do business in the State of Texas and licensed to issue such a bond in the State of Texas. The Contractor shall notify its corporate surety of any Contract changes.

4.10 The Contractor shall post with Owner, not later than ten (10) consecutive calendar days of Collin County Commissioners' Court award of Contract, a Payment Bond in the amount of one hundred percent (100%) of the total contract price in such form as is satisfactory to Owner, in compliance with Chapter 2253 of the Texas Government Code and all other applicable Texas Law, and on the form specified in the Contract Documents. This bond shall be executed by a corporate surety company duly authorized and admitted to do business in the State of Texas and licensed to issue such a bond in the State of Texas. The Contractor shall notify its corporate surety of any Contract changes.

4.11 The Contractor shall post with Owner, not later than ten (10) consecutive calendar days of Collin County Commissioners' Court award of Contract, a Maintenance Bond in the amount of ten percent (10%) of the total contract price in such form as is satisfactory to Owner, in compliance with Chapter 2253 of the Texas Government Code and all other applicable Texas Law, and on the

form specified in the Contract Documents. This bond shall be executed by a corporate surety company duly authorized and admitted to do business in the State of Texas and licensed to issue such a bond in the State of Texas. The Contractor shall notify its corporate surety of any Contract changes.

4.12 Overview: Site clearing, tree removal, engineered design and construction of two towers and twin zip lines estimated at 800' in length and approximately 60' high that runs along a wooded area at the Collin County Adventure Camp located in Anna, Texas. The reference points below provide an approximate start and end for the zip line. It is not intended for this project to be ADA accessible.

4.12.1 Twin Zip Approximate Locations

- | | |
|----------|---|
| 4.12.1.1 | Launch Tower and Zip Line Start N 33° 22.639' W 96° 28.130' |
| 4.12.1.2 | Base Platform and Zip Line End N 33° 22.496' W 28° 28.218' |

4.13 Requirements: The tower, platform and zip lines will be constructed in compliance with A.C.C.T. standards and local code requirements. All efforts will be made to leave the existing large trees over 24" and work around or under canopy of trees. All disturbed areas must be brought back to preconstruction condition. Submit preconstruction photos of construction and staging areas prior to construction. Contractors should have minimum 10 years related construction experience and provide project information and contacts for the last five zip line installations. The contractor is responsible for any permit cost, fees and or cost associated with required inspections.

4.14 Twin Zip Line Launch Tower: The Launch Tower will be built at an estimated height of 55' to finish floor. The Launch Tower will be a 16'x16' octagon shaped platform with 48" side railings, fixed wood benches around the 48" high side railings with a 28 gauge metal roof. The platform handrails and gates will be constructed to match the existing railings on the camp bridges (See sketches of Launch Tower (Attachments A and C) and photos of existing bridge construction (Section 4.18). The platform and the 16' X 16' prep deck will accommodate the staff, participants and those in line to ride the twin zip lines. All zip line equipment will be stored in a mounted job box on the prep deck. The tower will be accessed via a walk up staircase that is attached to the tower and prep deck. Provide an estimate 150' by 5' cleared trail with 3" of crushed granite no larger than 3/8 diameter with two courses of treated 3" landscape timbers secured with a 12" spike every two feet with a weed control fabric material under the base and timbers for a walk way built at 5% maximum slope to access the launch tower. Contractor to provide engineer stamped construction ready drawings and support documents for the Launch Tower with Prep Deck and Twin Zip Lines.

4.15 Twin Zip Line Base Landing Platform: At the base of the platform and approximately within 30' of the end of the zip line there will be a 24' x 32' wooden deck constructed with 48" tall railing on three sides consistent with the launch tower platform that has fixed wood benches attached around 3 sides for the participants to sit. There will be one job box located on this deck to

store zip line equipment and accessories. There will be a lockable gate at the platform walkway entry at the bridge to prevent access when the tower is not in use. The Base Landing Platform will be constructed at the required height based on travel distance from the Launch Tower as to allow a walk off ride. The Base Landing Platform will be connected to the existing trail bridge by a 48" wide wooden ramp walkway or stair depending on the recommended installation height. Contractor to provide engineer stamped construction ready drawings and support documents for the Base Landing Platform and Zip Lines. (See Attachments A-D for more information)

4.16 Contractor Provided Equipment and Accessories: Any reference to a brand/manufacturer describes Collin County's minimum requirement. Contractor shall submit documentation describing brand bid and how it meets or exceeds the minimum specification.

4.16.1 Sixteen (16) Zip Pulleys with Connector (K2 zip by PA or AEI Two Wheel Zip Pulley)

4.16.2 Fifty (50) Body Harnesses with Chest Harness (25 adult and 25 youth) (Headwall participant harness with Chest harness)

4.16.3 Eight (8) Lobster Claws (2 with Load limiting device)

4.16.4 Seventy-Five (75) Steel Auto Locking Carabineers (Omega Gold Steel Auto lock Carabineer)

4.16.5 Twenty-Five (25) Helmets (Pretzel Ecrin Roc Helmet – Adjustable)

4.16.6 Two (2) Rescue Bags (Each orange bag containing 120' ½" static rope, 1 small shear reduction block, 3 steel screw locking carabineers, 1 rescue figure 8, 1 daisy chain tether, 1 pair EMT scissors and sheath)

4.16.7 Two (2) Staff Harnesses (Headwall)

4.16.8 Three (3) Life Systems Mountain First Aid Kits

4.16.9 Two (2) Delta Job Box (part #637990 with 2 keyed alike Master pad locks)

4.16.10 Three (3) Rubbermaid 10-Gallon Water Cooler Orange Cooler Model # FG1610HDORAN

4.16.11 Four (4) Rubbermaid 23 gal. Gray Slim Jim Waste Container Model # FG 3540 GRA

4.17 Training Requirements: After the construction is completed the contractor will provide one copy of A.C.C.T. Zip Line Standards and provide a 30 minute DVD video recorded training secession for zip line riding techniques, personnel training, equipment training, and safety tips, zip line routine maintenance and zip line inspection requirements.

4.18 Close out and Warranty Requirements: Contractor to provide two bound copies of all as-built drawings, manufactures specification sheets, contractor provided equipment manufactures specification sheets and a contractor provided one year all inclusive warranty for all workmanship, materials and contractor provided hardware and equipment. Contractor is required to respond to

warranty request within 24 hours of warranty request. Contractor to include in proposal two addition site visits within 12 months after completed construction for any necessary zip line adjustments and or required maintenance on the two separate dates scheduled at the Owners request.

4.19 Pictures of Existing Conditions:

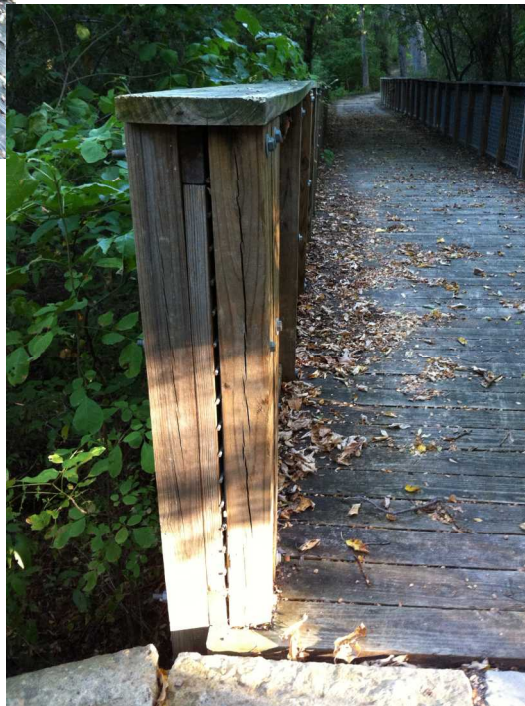

**SIGNATURE FORM
COLLIN COUNTY, TEXAS**

DELIVERY WILL BE F.O.B. INSIDE DELIVERY AT COLLIN COUNTY DESIGNATED LOCATIONS AND ALL TRANSPORTATION CHARGES PAID BY THE SUPPLIER TO DESTINATION.

DELIVERY TO BE SPECIFIED IN CALENDAR DAYS FROM DATE OF ORDER.

WE **DO NOT** TAKE EXCEPTION TO THE BID SPECIFICATIONS.

WE **TAKE** EXCEPTION TO THE BID SPECIFICATIONS (EXPLAIN):

COMPANY INFORMATION/PROFILE/REFERENCES

Preferential Requirement: The County of Collin, as a governmental agency of the State of Texas, may not award a contract to a nonresident bidder unless the nonresident's bid is lower than the lowest bid submitted by a responsible Texas resident bidder by the same amount that a Texas resident bidder would be required to underbid a nonresident bidder to obtain a comparable contract in the state in which the nonresident's principal place of business is located (Government Code, Title 10, V.T.C.A., Chapter 2252, Subchapter A). Bidder shall make answer to the following questions by selecting the appropriate radio button or inserting information in the box provided:

Is your principal place of business in the State of Texas? Yes No

If the answer to question is "yes", no further information is necessary; if "no", please indicate:

in which state is your principal place of business is located:

if that state favors resident bidders (bidders in your state) by some dollar increment or percentage: Yes No

if "yes", what is that dollar increment or percentage?

Company Profile: IS YOUR FIRM?

- Sole Proprietorship Yes No
- General Partnership Yes No
- Limited Partnership Yes No
- Corporation Yes No
- Other Yes No

List Legal Names in Company:

List at least three (3) companies or governmental agencies where these same/like products/services, as stated herein, have been provided. Include company name, address, contact name and telephone number.

AS PERMITTED UNDER TITLE 8, CHAPTER 271, SUBCHAPTER F, SECTION 271.101 AND 271.102 V.T.C.A. AND TITLE 7, CHAPTER 791, SUBCHAPTER C, SECTION 791.025, V.T.C.A., OTHER LOCAL GOVERNMENTAL ENTITIES MAY WISH TO ALSO PARTICIPATE UNDER THE SAME TERMS AND CONDITIONS CONTAINED IN THIS CONTRACT. EACH ENTITY WISHING TO PARTICIPATE MUST ENTER INTO AN INTERLOCAL AGREEMENT WITH COLLIN COUNTY AND HAVE PRIOR AUTHORIZATION FROM VENDOR. IF SUCH PARTICIPATION IS AUTHORIZED, ALL PURCHASE ORDERS WILL BE ISSUED DIRECTLY FROM AND SHIPPED DIRECTLY TO THE LOCAL GOVERNMENTAL ENTITY REQUIRING SUPPLIES/SERVICES. COLLIN COUNTY SHALL NOT BE HELD RESPONSIBLE FOR ANY ORDERS PLACED, DELIVERIES MADE OR PAYMENT FOR SUPPLIES/SERVICES ORDERED BY THESE ENTITIES. EACH ENTITY RESERVES THE RIGHT TO DETERMINE THEIR PARTICIPATION IN THIS CONTRACT. WOULD BIDDER BE WILLING TO ALLOW OTHER LOCAL GOVERNMENTAL ENTITIES TO PARTICIPATE IN THIS CONTRACT, IF AWARDED, UNDER THE SAME TERMS AND CONDITIONS? Yes No

By signing and submitting this Bid/Proposal, Bidder/Offeror acknowledges, understands the specifications, any and all addenda, and agrees to the bid/proposal terms and conditions and can provide the minimum requirements stated herein. Bidder/Offeror acknowledges they have read the document in its entirety, visited the site, performed investigations and verifications as deemed necessary, is familiar with local conditions under which work is to be performed and will be responsible for any and all errors in Bid/Proposal submittal resulting from Bidder/Offeror's failure to do so. Bidder/Offeror acknowledges the prices submitted in this Bid/Proposal have been carefully reviewed and are submitted as correct and final. If Bid/Proposal is accepted, vendor further certifies and agrees to furnish any and all products/services upon which prices are extended at the price submitted, and upon conditions in the specifications of the Invitation for Bid/Request for Proposal.

THE UNDERSIGNED HEREBY CERTIFIES THE FOREGOING BID/PROPOSAL SUBMITTED BY THE COMPANY LISTED BELOW HEREINAFTER CALLED "BIDDER/OFFEROR" IS THE DULY AUTHORIZED AGENT OF SAID COMPANY AND THE PERSON SIGNING SAID BID/PROPOSAL HAS BEEN DULY AUTHORIZED TO EXECUTE SAME. BIDDER/OFFEROR AFFIRMS THAT THEY ARE DULY AUTHORIZED TO EXECUTE THIS CONTRACT; THIS COMPANY; CORPORATION, FIRM, PARTNERSHIP OR INDIVIDUAL HAS NOT PREPARED THIS BID/PROPOSAL IN COLLUSION WITH ANY OTHER BIDDER/OFFEROR OR OTHER PERSON OR PERSONS ENGAGED IN THE SAME LINE OF BUSINESS; AND THAT THE CONTENTS OF THIS BID/PROPOSAL AS TO PRICES, TERMS AND CONDITIONS OF SAID BID/PROPOSAL HAVE NOT BEEN COMMUNICATED BY THE UNDERSIGNED NOR BY ANY EMPLOYEE OR AGENT TO ANY OTHER PERSON ENGAGED IN THIS TYPE OF BUSINESS PRIOR TO THE OFFICIAL OPENING OF THIS BID/PROPOSAL.

| | |
|---|-------------------------------|
| Company Name | <input type="text"/> |
| Street Address of Principal Place of Business | <input type="text"/> |
| City, State, Zip | <input type="text"/> |
| Phone of Principal Place of Business | <input type="text"/> |
| Fax of Principal Place of Business | <input type="text"/> |
| E-mail Address of Representative | <input type="text"/> |
| Federal Identification Number | <input type="text"/> |
| Date | <input type="text"/> |
| Acknowledgement of Addenda | #1 € #2 € #3 € #4 € #5 € #6 € |
| Authorized Representative Name | <input type="text"/> |
| Authorized Representative Title | <input type="text"/> |
| Signature (Required for paper bid submission) | <input type="text"/> |

Side View Launch Tower

ATTACHMENT A

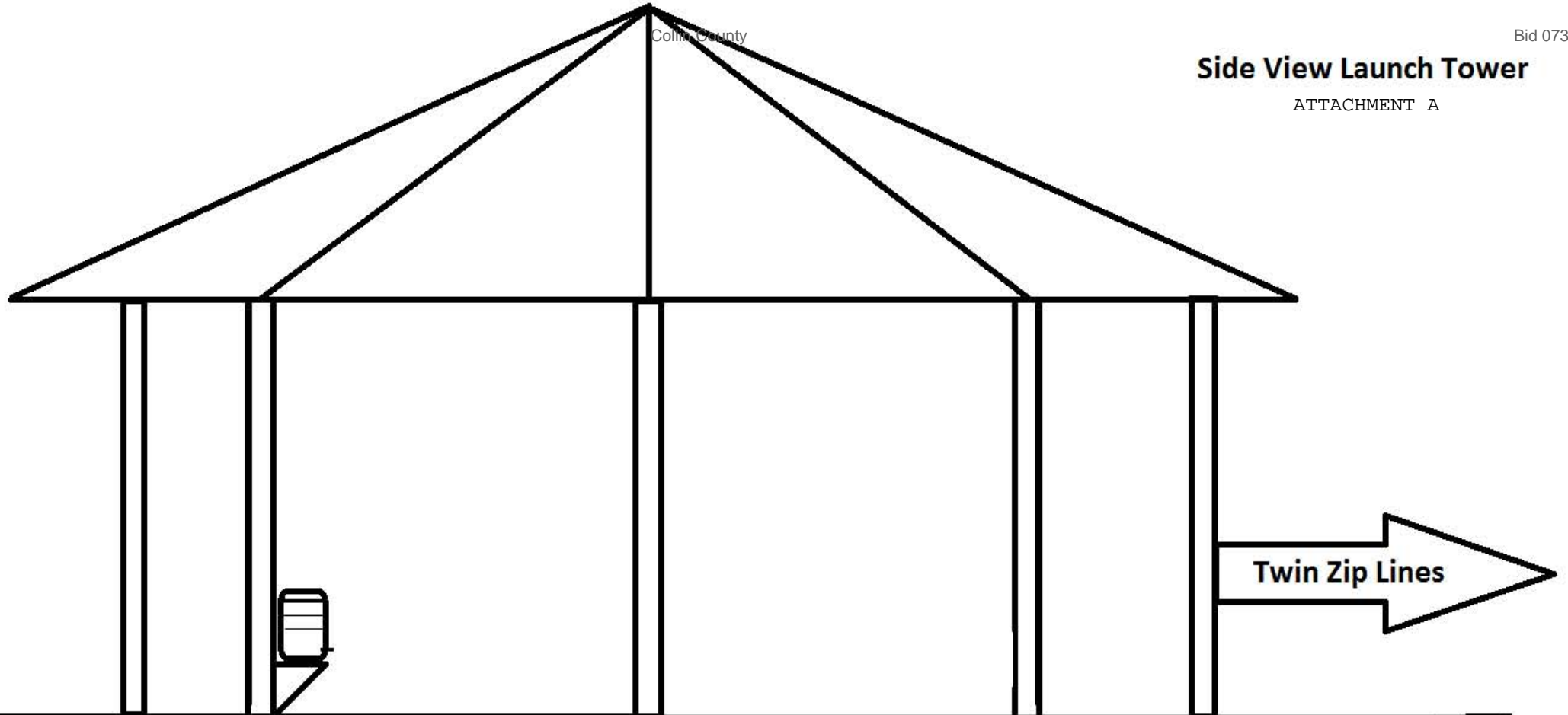

Twin Zip Lines

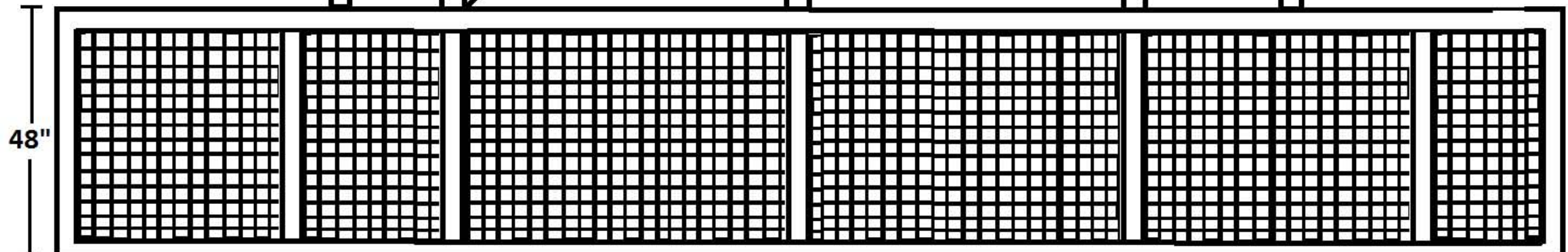

48"

Stair Case with 48" Rails
to match existing railings

Not to scale

Overview 16' X 16' Launch Platform

ATTACHMENT B

- ① 20" high bench
- ② 48" handrails
- ③ Dual gates with locking hardware
- ④ Job box
- ⑤ Mounted water cooler
- ⑥ Trash can
- ⑦ Stairs

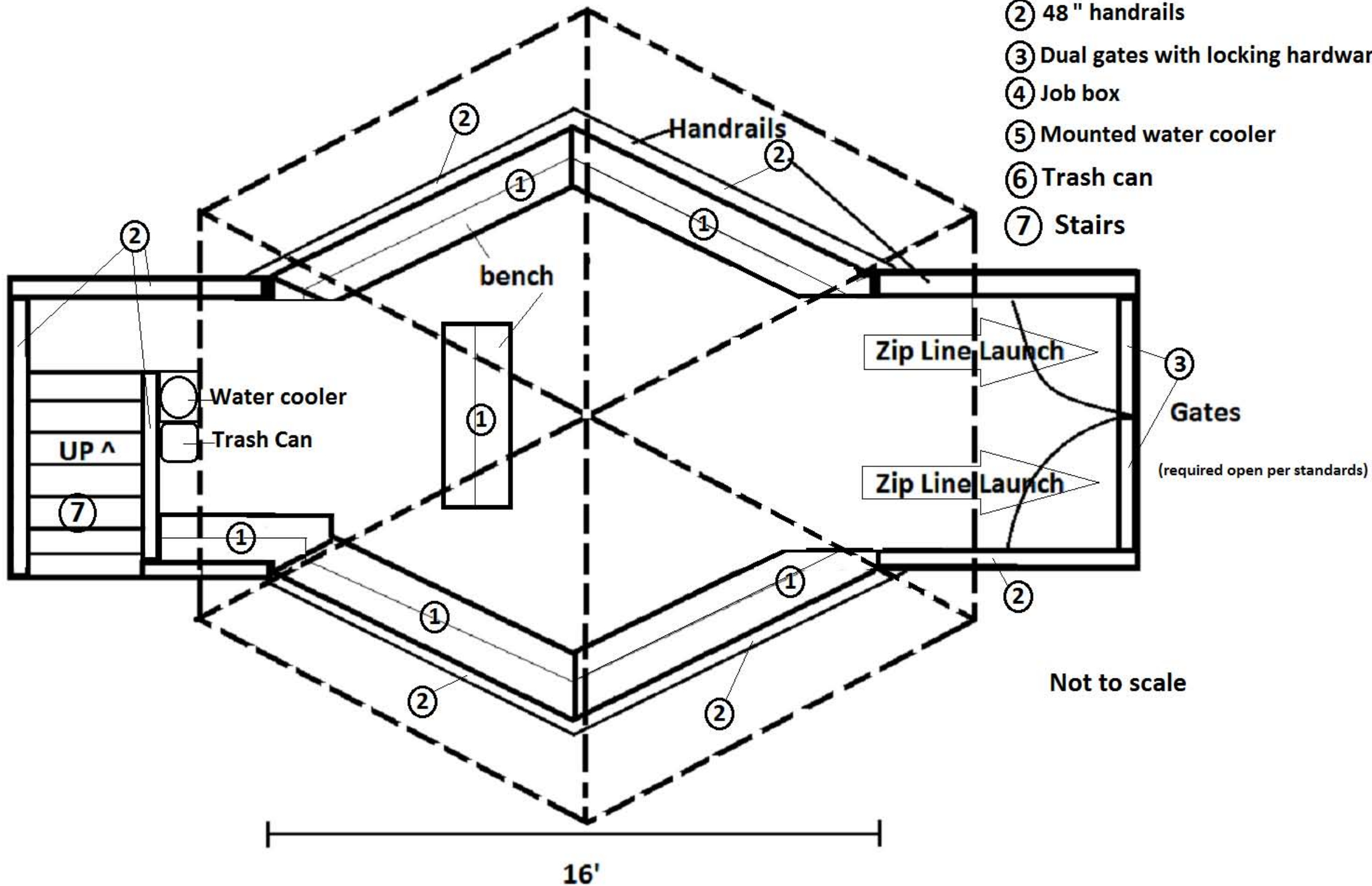

Base Platform

Collin County

ATTACHMENT C

Bid 07834-12

48"

Unknown Height

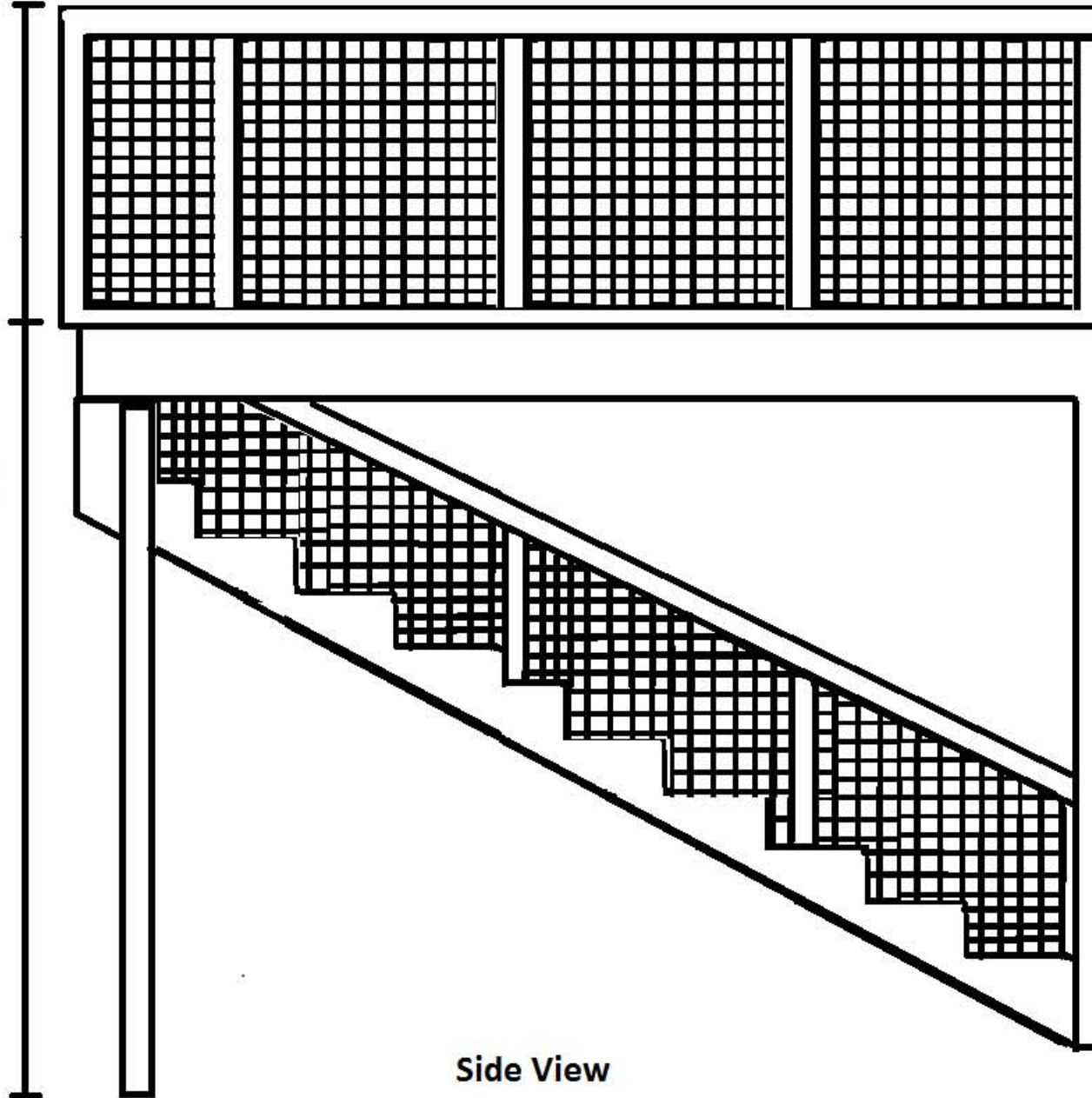

Side View

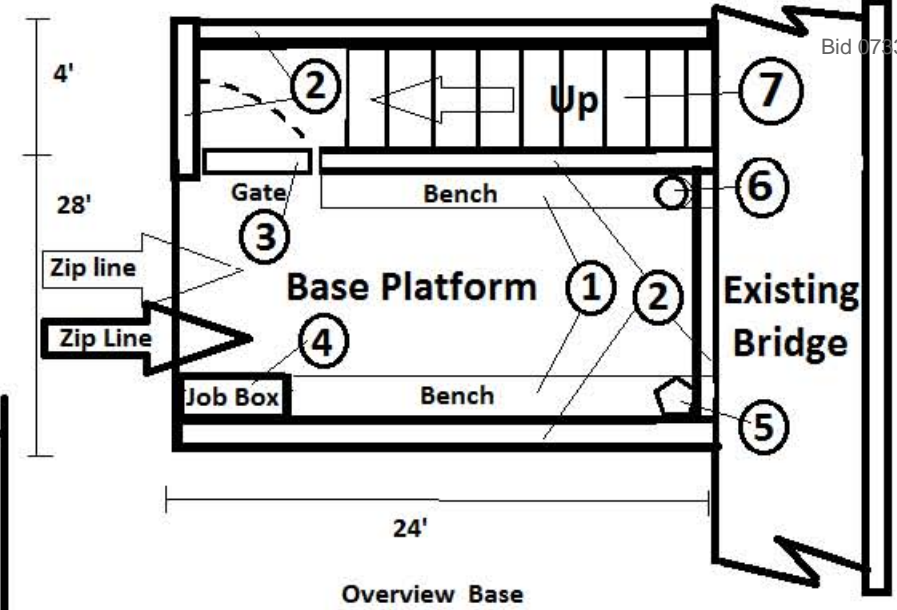

- ① 20" high bench
- ② 48" handrails
- ③ gate with locking hardware
- ④ Job box
- ⑤ Mounted water cooler
- ⑥ Trash can
- ⑦ Stairs

Existing Bridge

Not to scale

ATTACHMENT D

- ① 20 " high bench
- ② 48 " handrails
- ③ Dual gates with locking hardware
- ④ Job box
- ⑤ Mounted water cooler
- ⑥ Trash can

Launch Tower

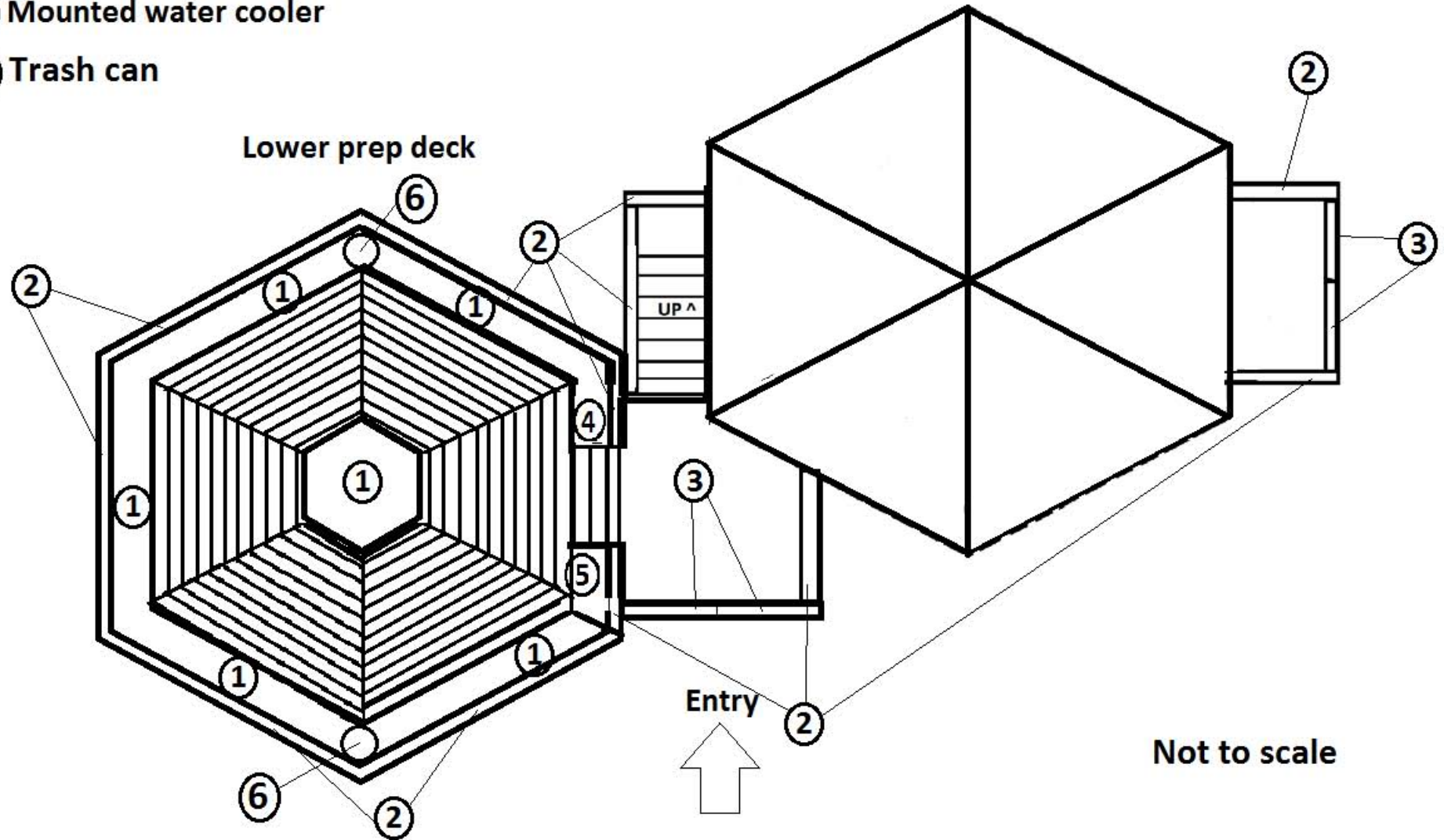

Not to scale

PAYMENT BOND

STATE OF TEXAS §
COUNTY OF COLLIN §

KNOW ALL MEN BY THESE PRESENTS:

That _____, a corporation organized and existing under the laws of the State of _____, and fully authorized to transact business in the State of Texas, whose address is _____ of the City of _____ County of _____, and State of _____, (hereinafter referred to as "Principal"), and _____ (hereinafter referred to as "Surety", a corporation organized under the laws of the State of _____ and authorized under the laws of the State of Texas to act as surety on bonds for principals, are held and firmly bound unto _____ (hereinafter referred to as "Owner") and unto all persons, firms and corporations who may furnish materials for or perform labor upon the buildings, structures or improvements referred to in the attached Contract, in the penal sum of _____ Dollars (\$ _____) (not less than 100% of the approximate total amount of the Contract as evidenced in the proposal) in lawful money of the United States, for the payment whereof, the said Principal and Surety bind themselves, and their heirs, administrators, executors, successors, and assigns, jointly and severally, firmly by these presents:

WHEREAS, the Principal has entered into a certain written contract with the Owner, dated the _____ day of _____, 201____, to which said Contract is hereby referred to and made a part hereof and as fully and to the same extent as if copied at length herein for the construction of _____

NOW, THEREFORE, THE CONDITION OF THIS OBLIGATION IS SUCH, that the bond guarantees the full and proper protection of all claimants supplying labor and material in the prosecution of the work provided for in said Contract and for the use of each claimant, and that conversely should the Principal faithfully perform said Contract and in all respects duly and faithfully observe and perform all and singular the covenants, conditions, and agreements in and by said Contract, agreed to by the Principal, and according to the true intent and meaning of said Contract and the claims and specifications hereto annexed, and any and all duly authorized modifications of said Contract that may hereafter be made, notice of which modification to Surety being hereby waived, then this obligation shall be void; otherwise, to remain in full force and effect. Provided further, that if any legal action be filed on this Bond, venue shall lie in Collin County, Texas.

"PROVIDED, HOWEVER, that this bond is executed pursuant to the provisions Texas Government Code, Chapter 2253, as amended, and Chapter 3503 of the Texas Insurance Code, as amended, and all liabilities on this bond shall be determined in accordance with the provisions of said articles to the same extent as if they were fully copied at length herein.

Surety, for value received, stipulates and agrees that the bond shall automatically be increased by the amount of any Change Order or supplemental agreement which increases the Contract price with or without notice to the Surety and that no change, extension of time, alteration or addition to the terms of the Contract, or to the work performed thereunder, or the plans, specifications, or drawings accompanying the same, shall in anyway affect its obligation on this bond, and it does hereby waive notice of any such change, extension of time, alteration or addition to the terms of the Contract, or to the work to be performed thereunder.

The undersigned and designated agent is hereby designated by Surety herein as the agent resident to whom any requisite notice may be delivered and on whom service of process may be had in matters arising out of such suretyship.

IN WITNESS WHEREOF, the said Principal and Surety have signed and sealed this instrument this _____ day of _____ 201____.

WITNESS

PRINCIPAL

Printed/Typed Name _____

Title: _____

Company: _____

Address: _____

SURETY

Printed/Typed Name _____

Title: _____

Company: _____

Address: _____

WITNESS

The Resident Agent of the Surety for delivery of notice and service of process is:
Name: _____
Address: _____
Phone Number: _____

Note: Date of Bond must NOT be prior to date of contract.

PERFORMANCE BOND

STATE OF TEXAS §
COUNTY OF COLLIN §

KNOW ALL MEN BY THESE PRESENTS:

That _____, a corporation organized and existing under the laws of the State of _____, and fully authorized to transact business in the State of Texas, whose address is _____ of the City of _____ County of _____, and State of _____, (hereinafter referred to as "Principal"), and _____ (hereinafter referred to as "Surety", a corporation organized under the laws of the State of _____ and authorized under the laws of the State of Texas to act as surety on bonds for principals, are held and firmly bound unto _____ (hereinafter referred to as "Owner") and unto all persons, firms and corporations who may furnish materials for or perform labor upon the buildings, structures or improvements referred to in the attached Contract, , in the penal sum of _____ Dollars (\$ _____) (not less than 100% of the approximate total amount of the Contract as evidenced in the proposal plus 10-percent of the stated penal sum as an additional sum of money representing additional court expenses, attorneys' fees, and liquidated damages arising out of or connected with the below identified Contract) in lawful money of the United States, for the payment whereof, the said Principal and Surety bind themselves, and their heirs, administrators, executors, successors, and assigns, jointly and severally, firmly by these presents:

WHEREAS, the Principal has entered into a certain written contract with the Owner, dated the _____ day of _____, 201____, to which said Contract is hereby referred to and made a part hereof and as fully and to the same extent as if copied at length herein for the construction of _____

NOW, THEREFORE, THE CONDITION OF THIS OBLIGATION IS SUCH, that if the said Principal fully and faithfully executes the work and performance of the Contract in accordance with the plans specifications, and Contract Documents, including any extensions thereof which may be granted with or without notice to Surety, during the original term thereof, and during the life of any guaranty required under the Contract, and according to the true intent and meaning of said Contract and the plans and specifications hereto annexed, if the Principal shall repair and/or replace all defects due to faulty materials or workmanship that appear within a period of one year from the date of final completion and final acceptance of the work by OWNER; and if the Principal shall fully indemnify and save harmless the OWNER from all costs and damages which OWNER may suffer by reason of failure to so perform herein and shall fully reimburse and repay OWNER all outlay and expense which the OWNER may incur in making good any default or deficiency, then this obligation shall be void; otherwise, to remain in full force and effect; and in case said CONTRACTOR shall fail to do so, it is agreed that the OWNER may do said work and supply such materials and charge the same against said CONTRACTOR and Surety on this obligation. Provided further, that if any legal action be filed on this Bond, venue shall lie in Collin County, Texas.

"PROVIDED, HOWEVER, that this bond is executed pursuant to the provisions Texas Government Code, Chapter 2253, as amended, and Chapter 3503 of the Texas Insurance Code, as amended, and all liabilities on this bond shall be determined in accordance with the provisions of said articles to the same extent as if they were fully copied at length herein.

Surety, for value received, stipulates and agrees that the bond shall automatically be increased by the amount of any Change Order or supplemental agreement which increases the Contract price with or without notice to the Surety, but in no event shall a Change Order or Supplemental Agreement which reduces the Contract price decrease the penal sum of the Bond. And further that no change, extension of time, alteration, or addition to the terms of the Contract, or to the work performed thereunder, or the plans, specifications, or drawings accompanying the same shall in any way affect its obligation on this bond, and it does hereby waive notice of any such change, extension of time, alteration, or addition to the terms of the Contract or to the work to be performed thereunder.

Surety agrees that the bond provides for the repairs and/or replacement of all defects due to faulty materials and workmanship that appear within a period of one (1) year from the date of completion and acceptance of the improvement by the OWNER.

The undersigned and designated agent is hereby designated by Surety herein as the agent resident to whom any requisite notice may be delivered and on whom service of process may be had in matters arising out of such suretyship.

IN WITNESS WHEREOF, the said Principal and Surety have signed and sealed this instrument this _____ day of _____ 201____.

WITNESS

PRINCIPAL

Printed/Typed Name _____
Title: _____
Company: _____

Address: _____

WITNESS

SURETY

Printed/Typed Name _____
Title: _____
Company: _____

Address: _____

The Resident Agent of the Surety for delivery of notice and service of process is:
Name: _____
Address: _____
Phone Number: _____

Note: Date of Bond must NOT be prior to date of contract.

Revised 11/2008

00611 MAINTENANCE BOND

STATE OF TEXAS §
COUNTY OF COLLIN §

KNOW ALL MEN BY THESE PRESENTS:

That _____, a corporation organized and existing under the laws of the State of _____, and fully authorized to transact business in the State of Texas, whose address is _____ of the City of _____ County of _____, and State of _____, (hereinafter referred to as "Principal"), and _____ (hereinafter referred to as "Surety", a corporation organized under the laws of the State of _____ and authorized under the laws of the State of Texas to act as surety on bonds for principals, are held and firmly bound unto _____ (hereinafter referred to as "Owner") and unto all persons, firms and corporations who may furnish materials for or perform labor upon the buildings, structures or improvements referred to in the attached Contract, , in the penal sum of _____ Dollars (\$ _____) in lawful money of the United States, for the payment whereof, the said Principal and Surety bind themselves, and their heirs, administrators, executors, successors, and assigns, jointly and severally, firmly by these presents:

WHEREAS, the Principal has entered into a certain written contract with the Owner, dated the _____ day of _____, 201____, to which said Contract is hereby referred to and made a part hereof and as fully and to the same extent as if copied at length herein for the construction of IFB 09298-11, Construction, Myers Park Amphitheater and Toilets.

NOW, THEREFORE, THE CONDITION OF THIS OBLIGATION IS SUCH, that the bond guarantees the full and proper maintenance and repair of the work herein contracted to be done and performed for a period of _____ year(s) from the date of acceptance and Principal will do all necessary backfilling that may arise on account of sunken conditions in ditches, or otherwise, and do and perform all necessary work and repair any defective condition growing out of or arising from the improper laying or construction of same, or on account of any breaking of same caused by said CONTRACTOR in construction of same , or on account of any defect arising in any of said work laid or constructed by said CONTRACTOR or on account of improper excavation or backfilling, it being understood that the purpose of this section is to cover all defective conditions arising by reason of defective materials, work or labor performed by said CONTRACTOR, then this obligation shall be void; otherwise, to remain in full force and effect; and in case said CONTRACTOR shall fail to do so, it is agree that the OWNER may do said work and supply such materials and charge the same against said CONTRACTOR and Surety on this obligation. Provided further, that if any legal action be filed on this Bond, venue shall lie in Collin County, Texas.

"PROVIDED, HOWEVER, that said Surety, for value received, stipulates and agrees the bond shall automatically be increased by the amount of any Change Order or supplemental agreement which increases the Contract price with or without notice to the Surety and that no change, extension of time, alteration or addition to the terms of the Contract, or to the work performed thereunder, or the plans specifications, or drawings accompanying the same shall in any way affect its obligation on this bond, and it does hereby waive notice of any such change, extension of time, alteration, or addition to the terms of the Contract or to the work to be performed thereunder.

The undersigned and designated agent is hereby designated by Surety herein as the agent resident to whom any requisite notice may be delivered and on whom service of process may be had in matters arising out of such suretyship.

IN WITNESS WHEREOF, the said Principal and Surety have signed and sealed this instrument this _____ day of _____ 201____ .

WITNESS

PRINCIPAL

Printed/Typed Name _____

Title: _____

Company: _____

Address: _____

WITNESS

SURETY

Printed/Typed Name _____

Title: _____

Company: _____

Address: _____

The Resident Agent of the Surety for delivery of notice and service of process is:
Name: _____
Address: _____
Phone Number: _____

Note: Date of Bond must NOT be prior to date of contract.

Revised 11/2008

Form **W-9**
(Rev. October 2007)
Department of the Treasury
Internal Revenue Service

Request for Taxpayer Identification Number and Certification

**Give form to the
requester. Do not
send to the IRS.**

| | | |
|---|--|---|
| Print or type See Specific Instructions on page 2. | Name (as shown on your income tax return) | |
| | Business name, if different from above | |
| | Check appropriate box: <input type="checkbox"/> Individual/Sole proprietor <input type="checkbox"/> Corporation <input type="checkbox"/> Partnership <input type="checkbox"/> Limited liability company. Enter the tax classification (D=disregarded entity, C=corporation, P=partnership) ▶ <input type="checkbox"/> Other (see instructions) ▶ | <input type="checkbox"/> Exempt payee |
| | Address (number, street, and apt. or suite no.) | Requester's name and address (optional) |
| | City, state, and ZIP code | |
| List account number(s) here (optional) | | |

Part I Taxpayer Identification Number (TIN)

Enter your TIN in the appropriate box. The TIN provided must match the name given on Line 1 to avoid backup withholding. For individuals, this is your social security number (SSN). However, for a resident alien, sole proprietor, or disregarded entity, see the Part I Instructions on page 3. For other entities, it is your employer identification number (EIN). If you do not have a number, see *How to get a TIN* on page 3.

Note. If the account is in more than one name, see the chart on page 4 for guidelines on whose number to enter.

| |
|--------------------------------|
| Social security number |
| : : |
| : : |
| or |
| Employer identification number |
| : : |

Part II Certification

Under penalties of perjury, I certify that:

1. The number shown on this form is my correct taxpayer identification number (or I am waiting for a number to be issued to me), and
2. I am not subject to backup withholding because: (a) I am exempt from backup withholding, or (b) I have not been notified by the Internal Revenue Service (IRS) that I am subject to backup withholding as a result of a failure to report all interest or dividends, or (c) the IRS has notified me that I am no longer subject to backup withholding, and
3. I am a U.S. citizen or other U.S. person (defined below).

Certification instructions. You must cross out item 2 above if you have been notified by the IRS that you are currently subject to backup withholding because you have failed to report all interest and dividends on your tax return. For real estate transactions, item 2 does not apply. For mortgage interest paid, acquisition or abandonment of secured property, cancellation of debt, contributions to an individual retirement arrangement (IRA), and generally, payments other than interest and dividends, you are not required to sign the Certification, but you must provide your correct TIN. See the instructions on page 4.

| | | |
|------------------|----------------------------|--------|
| Sign Here | Signature of U.S. person ▶ | Date ▶ |
|------------------|----------------------------|--------|

General Instructions

Section references are to the Internal Revenue Code unless otherwise noted.

Purpose of Form

A person who is required to file an information return with the IRS must obtain your correct taxpayer identification number (TIN) to report, for example, income paid to you, real estate transactions, mortgage interest you paid, acquisition or abandonment of secured property, cancellation of debt, or contributions you made to an IRA.

Use Form W-9 only if you are a U.S. person (including a resident alien), to provide your correct TIN to the person requesting it (the requester) and, when applicable, to:

1. Certify that the TIN you are giving is correct (or you are waiting for a number to be issued),
2. Certify that you are not subject to backup withholding, or
3. Claim exemption from backup withholding if you are a U.S. exempt payee. If applicable, you are also certifying that as a U.S. person, your allocable share of any partnership income from a U.S. trade or business is not subject to the withholding tax on foreign partners' share of effectively connected income.

Note. If a requester gives you a form other than Form W-9 to request your TIN, you must use the requester's form if it is substantially similar to this Form W-9.

Definition of a U.S. person. For federal tax purposes, you are considered a U.S. person if you are:

- An individual who is a U.S. citizen or U.S. resident alien,
- A partnership, corporation, company, or association created or organized in the United States or under the laws of the United States,
- An estate (other than a foreign estate), or
- A domestic trust (as defined in Regulations section 301.7701-7).

Special rules for partnerships. Partnerships that conduct a trade or business in the United States are generally required to pay a withholding tax on any foreign partners' share of income from such business. Further, in certain cases where a Form W-9 has not been received, a partnership is required to presume that a partner is a foreign person, and pay the withholding tax. Therefore, if you are a U.S. person that is a partner in a partnership conducting a trade or business in the United States, provide Form W-9 to the partnership to establish your U.S. status and avoid withholding on your share of partnership income.

The person who gives Form W-9 to the partnership for purposes of establishing its U.S. status and avoiding withholding on its allocable share of net income from the partnership conducting a trade or business in the United States is in the following cases:

- The U.S. owner of a disregarded entity and not the entity,

| CONFLICT OF INTEREST QUESTIONNAIRE FORM CIQ For vendor or other person doing business with local governmental entity | |
|--|--|
| <p>This questionnaire is being filed in accordance with chapter 176 of the Local Government Code by a person doing business with the governmental entity.</p> <p>By law this questionnaire must be filed with the records administrator of the local government not later than the 7th business day after the date the person becomes aware of facts that require the statement to be filed. See Section 176.006, Local Government Code.</p> <p>A person commits an offense if the person violates Section 176.006, Local Government Code. An offense under this section is a Class C misdemeanor.</p> | OFFICE USE ONLY <hr/> Date Received |
| 1 | <p>Name of person doing business with local governmental entity.</p> <div style="border: 1px solid black; height: 20px; width: 100%; margin-top: 5px;"></div> |
| 2 | <p><input type="checkbox"/> Check this box if you are filing an update to a previously filed questionnaire.</p> <p>(The law requires that you file an updated completed questionnaire with the appropriate filing authority not later than September 1 of the year for which an activity described in Section 176.006(a), Local Government Code, is pending and not later than the 7th business day after the date the originally filed questionnaire becomes incomplete or inaccurate.)</p> |
| 3 | <p>Name each employee or contractor of the local governmental entity who makes recommendations to a local government officer of the governmental entity with respect to expenditures of money AND describe the affiliation or business relationship.</p> <div style="border: 1px solid black; height: 100px; width: 100%; margin-top: 5px; position: relative;"> <div style="position: absolute; right: -20px; top: 50%; transform: translateY(-50%); background: repeating-linear-gradient(45deg, transparent, transparent 2px, #ccc 2px, #ccc 4px); width: 10px; height: 100%;"></div> </div> |
| 4 | <p>Name each local government officer who appoints or employs local government officers of the governmental entity for which this questionnaire is filed AND describe the affiliation or business relationship.</p> <div style="border: 1px solid black; height: 100px; width: 100%; margin-top: 5px; position: relative;"> <div style="position: absolute; right: -20px; top: 50%; transform: translateY(-50%); background: repeating-linear-gradient(45deg, transparent, transparent 2px, #ccc 2px, #ccc 4px); width: 10px; height: 100%;"></div> </div> |

Adopted 11/02/2005

FORM CIQ

CONFLICT OF INTEREST QUESTIONNAIRE

Page 2

For vendor or other person doing business with local governmental entity

**5 Name of local government officer with whom filer has affiliation or business relationship.
(Complete this section only if the answer to A, B, or C is YES.)**

This section, item 5 including subparts A, B, C & D, must be completed for each officer with whom the filer has affiliation or other relationship. Attach additional pages to this Form CIQ as necessary.

A. Is the local government officer named in this section receiving or likely to receive taxable income from the filer of the questionnaire? Yes No

B. Is the filer of the questionnaire receiving or likely to receive taxable income from or at the direction of the local government officer named in this section AND the taxable income is not from the local governmental entity? Yes No

C. Is the filer of this questionnaire affiliated with a corporation or other business entity that the local government officer serves as an officer or director, or holds an ownership of 10 percent or more? Yes No

D. Describe each affiliation or business relationship.

6

Signature of person doing business with the governmental entity

Date

Adopted 11/02/2005

AFFIDAVIT OF COMPLIANCE

I, the undersigned, declare and affirm that my company is in compliance with the Immigration and Reform Act of 1986 and all employees are legally eligible to work in the United States of America.

I further understand and acknowledge that any non-compliance with the Immigration and Reform Act of 1986 at any time during the term of this contract will render the contract voidable.

| | |
|------------------|----------------------|
| Name of Company | <input type="text"/> |
| Title of Officer | <input type="text"/> |
| Name of Officer | <input type="text"/> |
| Date: | <input type="text"/> |

Question and Answers for Bid #07334-12 - Construction, Towers and Zip Lines

OVERALL BID QUESTIONS

There are no questions associated with this bid. If you would like to submit a question, please click on the "Create New Question" button below.